

SKF Flowline monitor FL15, FL50 & FL100

(Operating and maintenance instructions compliant with EU Directive 2014/30/EU)



TABLE OF CONTENTS

1 EU Declaration of Conformity	4
2 Legal disclosure	5
Manufacturer	5
Training courses.....	5
Copyright	5
Warranty.....	5
Disclaimer.....	5
3 Explanation of symbols, signs and abbreviations.....	6
4 Safety instructions	9
4.1 General instructions	9
4.2 General behaviour when handling the product.....	9
4.3 Intended use	9
4.4 Foreseeable misuse	10
4.5 Painting of plastic parts prohibited.....	10
4.6 Unauthorized modifications to the product	10
4.7 Prohibition of certain activities	10
4.8 Compliance with other applicable documents	10
4.9 Notes concerning the type identification plate	11
4.10 Notes concerning CE marking.....	11
4.11 Persons authorised to operate the device	11
4.11.1 Operators	11
4.11.2 Mechanical specialist	11
4.11.3 Electrician.....	11
4.11.4 Providing briefing for external technicians	12
4.11.5 Provision of personal protective equipment.....	12
4.12 Operation	12
4.12.1 Emergency stopping of the pump station	12
4.12.2 Transport, installation, maintenance, malfunctions, repair, shutdown, disposal	12
4.13 Commissioning and daily start-up	13
4.14 Cleaning.....	13
4.15 Residual risk	14
5 Delivery, returns and storage.....	15
5.1 Delivery	15
5.2 Returns	15
5.3 Storage	15
6 Lubricants	16
6.1 General information	16
6.2 Lubrication selection	16
6.1 Material compatibility	17
6.2 Ageing of lubricants	17
7 General description	18
8 Design.....	18
8.1 SKF Flowline monitor FL15	18
8.2 SKF Flowline monitor FL50	19
8.3 SKF Flowline monitor FL100	19
9 Operation.....	20

9.1 General	20
9.2 LEDs in flow meters	21
9.3 User's interface in the control unit	22
9.4 Selecting a flow meter	24
9.5 Selecting display mode.....	24
9.6 Flow rate adjustment	24
9.6.1 FL15 and FL50 flow meter adjustment	24
9.6.2 FL100 flow meter adjustment.....	25
9.7 Start-up sequence	25
10 Settings.....	26
10.1 General	26
10.2 Entering the setting mode.....	26
10.3 Exiting the setting mode	27
10.3.1 Saving parameters and exiting	27
10.3.2 Exiting without saving parameters	27
10.4 Flow meter-specific settings	27
10.4.1 Nominal flow rate	27
10.4.2 Alarm limits.....	28
10.4.3 Alarm filtering	28
10.4.4 Optional flow meter- specific settings	29
10.4.5 Flow meter shutdown and start-up.....	29
10.5 Monitor-specific settings	30
10.5.1 Display units for flow rate and temperature	30
10.5.2 Oil viscosity grade	30
10.5.3 Flow meter type.....	30
10.5.4 Pre-alarm limit	31
10.5.5 Alarm mode of Relay-CAN module.....	31
10.5.6 CAN-bus ID-number.....	31
11 Installation.....	32
11.1 Mechanical installation.....	32
11.1.1 Monitor dimensions	32
11.1.2 Pipe connections.....	33
11.2 Electrical connections.....	35
12 Maintenance	38
12.1.1 Removing and reinstalling sensor.....	38
12.1.2 Removing and reinstalling flowmeter cover	40
12.1.3 Removing and reinstalling flow tube assembly.....	41
12.1.4 Removing and reinstalling flow valve.....	42
12.1.5 Removing and reinstalling motherboard	43
12.1.6 Installing optional Relay-CAN, mA-output or CAN module.....	43
13 Technical specifications	44
14 Optional modules	46
14.1 Relay-CAN module overall	46
14.1.1 Relay general description	46
14.1.2 Operation of alarm relays.....	47
Individual alarms (SHL, SL)	47
Individual alarms (DHL, DL and HL)	48
Individual alarms (DHL and DL)	48

Individual alarms (HL)	49
Common alarms (C).....	50
Fault message.....	50
14.2 CAN module	52
14.2.1 CAN bus connectors	53
14.3 mA-output module	53
14.3.1 Features	54
14.3.2 Scaling of the analog outputs.....	54
14.3.3 Connections	55
15 Troubleshooting	57
16 Cleaning.....	58
16.1 Cleaning agents.....	58
16.2 Exterior cleaning.....	58
16.3 Interior cleaning	58
17 Spare parts	59

1 EU Declaration of Conformity

(Declaration of conformity according to EMC Directive 2014/30/EU)

Oy SKF Ab
Teollisuustie 6 (P.O. Box 80)
FIN-40951 MUURAME
FINLAND

herewith declares that the product

SKF Flowline monitor FL15, FL50 and FL100

conforms to the relevant requirements of directives

EMC	2014/30/EU
RoHS II	2011/65/EU, (EU) 2015/863

The following harmonized standards have been applied:

- EN 61000-6-4:2007+A1:2011, for emissions
- EN 61000-6-2:2005, for immunity
- EN 50581:2013

Muurame
Place

April 11, 2017
Date



Juha Kärkkäinen
*Manager R&D Nordic
SKF Lubrication Business unit*

2 Legal disclosure

Manufacturer

Oy SKF Ab Finland
Teollisuustie 6
FI-40951 MUURAME
FINLAND
Tel: +358 20 7400 800
Fax: +358 20 7400 899
E-mail: skf-lube@skf.com
www.skf.com/lubrication

Training courses

In order to provide a maximum of safety and economic viability, SKF carries out detailed training courses. It is recommended that the training courses are attended. For further information, please contact the provided SKF Service address.

Copyright

© SKF. All rights reserved.

Warranty

The instructions do not contain any information concerning warranties. Warranties and guarantees are described in our general terms and conditions. Notes related to the operating instructions The present operating instructions are original operating instructions of the manufacturer pursuant to Machinery Directive 2006/42/EC. The instructions are part of the described products and must be kept in an accessible location for further use.

Disclaimer

The manufacturer shall not be held responsible for damages caused by:









- accidents, or negligent or inappropriate use, assembly, operation, configuration, maintenance or repairs
- improper or late response to malfunctions
- unauthorised modifications to the product
- intent or negligence
- the use of non-original (non-SKF) spare parts



Liability for loss or damage resulting from the use of our products is limited to the maximum purchase price. Liability for consequential damages of any kind is excluded.

3 Explanation of symbols, signs and abbreviations

The following symbols are used in the safety instructions included in this manual to highlight conditions which are potentially harmful to people, materials or the environment.

Please follow the instructions provided especially in the highlighted conditions. Also, be sure that all operators read this manual and all safety instructions.

	General warning		Risk of electric shock
	Risk of falling		Hot surface
	Fire hazard		Wear personal protective equipment (goggles)
	General notes		Disposal, recycling
	Dispose of cartridges in an environmentally friendly way		

	Warning level	Consequence	Probability
	DANGER	Death, serious injury	imminent
	WARNING	Death, serious injury	possible
	CAUTION	Minor injury	possible
	NOTICE	Property damage	possible

Symbol		Meaning			
●		Chronological guidelines			
○		List items			
✓		Indicates conditions which must be met before the activities described in the title clause can be completed			
☞		Also indicates other factors, causes or consequences			
re.	regarding	°C	degrees Celsius	°F	degrees Fahrenheit
approx.	approximately	K	Kelvin	Oz.	Ounce
i.e.	that is	N	Newton	≥	Equal to or greater then
etc.	et cetera	h	hour	≤	Equal to or less then
poss.	possibly	s	second	mm ²	square millimetre
if appl.	if applicable	d	day	fl. oz.	fluid ounce
a.a.r.	as a rule	Nm	Newtonmeter	in.	inch
incl.	including	ml	millilitre	Pa	Pascal newton per squar meter N/m ²
min.	minimum	l/min	Liter per minute	bar	bar, 100 kPa
max.	maximum	gal/min	Gallons per minute	PSI	pounds per square inch
min	minute	pint/min	Pints per minute	sq.in.	square inch
etc.	et cetera	cc	cubic centimetre	cu. in.	cubic inch
e.g.	for example	mm	millimetre	mph	miles per hour
kW	kilowatt	l	litre	rpm	revolutions per minute
V	volt	dB (A)	sound pressure level	gal.	gallon
W	watt	>	greater than	lb.	pound
AC	alternating current	<	less then	hp	horse power
DC	direct current	±	plus/minus	kp	kilopound
A	ampere	∅	diameter	fpsec	feet per second
Ah	ampere hour	kg	kilogram	cSt	centistoke
Hz	frequency (hertz)	RH	relative humidity	µm	micron
NC	normally closed	≈	approximately		
NO	normally open	=	equal to		
		%	pre cent		
		‰	per mille		

Conversion factors	
length	1 mm = 0,03937 in.
area	1 cm ² = 0,155 sq.in
volume	1 ml = 0,0352 fl.oz.
	1 l = 2,11416 pint (US), 0,264 gallons (US)
mass	1 kg = 2,205 lbs
	1 g = 0,03527 oz.
density	1 kg/cm ³ = 8,3454 lb./gal (US)
	1 kg/cm ³ = 0.03613 lb./cu.in.
force	1 N = 0,10197 kp
pressure	1 bar = 14,5 psi, 100 kPA
temperature	°C = (°F-32) x 5/9

output	1 kW = 1,34109 hp
acceleration	1 m/s ² = 3,28084 ft./s ²
speed	1 m/s = 3,28084 f/s
	1 m/s = 2,23694 m/h

4 Safety instructions

4.1 General instructions

- These safety instructions should be read and followed by any persons working on the product and those who supervise or instruct the group of persons mentioned above. In addition, the owner must ensure that the relevant personnel are fully familiar with the contents of the instructions.
- These instructions must be kept near these products for periodic review and for review by new users of these products.
- The described products have been manufactured according to the state of the art. However, if the products are used for other than their intended purpose, there may be new risks that arise which may result in personal injury or property damage.
- Any malfunctions which may affect safety must be remedied immediately. In addition to these instructions, general statutory regulations for accident prevention and environmental protection must be observed

4.2 General behaviour when handling the product

- Please follow these instructions whenever you use the product. If the product is not in proper and safe technical condition or you are unaware of the potential hazards, do not use the product.
- Familiarize yourself with the functions and operation of the product. All specified assembly and operating steps must be completed in the indicated order.
- Any points regarding proper and safe condition or correct assembly/operation that you do not understand must be clarified. Operation is prohibited until issues have been clarified.
- Keep unauthorized persons away.
- Always wear appropriate personal protective equipment.
- Responsibilities for different activities must be clearly defined and observed. Uncertainty is a major risk factor for safety.
- Safeguards and other protective and emergency equipment must not be removed, modified, disconnected or otherwise disabled. Their completeness and function must also be checked at regular intervals.
- If a safeguard or other protective equipment has to be detached, it must be reattached and tested immediately after the work is complete and before using the product.
- Remedy any faults included in your area of responsibility. If the fault is beyond your competence, notify your supervisor immediately of the fault.
- Do not stand on or climb on any parts of the centralised lubrication system or of the machine.

4.3 Intended use

This equipment supplies lubricants within a centralised lubrication system in accordance with the specifications, technical data and limits stated in these instructions:

Usage is allowed exclusively for professional users in commercial and economic activities.

4.4 Forseeable misuse

Any use differing from that stated in these instructions is strictly prohibited, particularly the following:

- Use outside the indicated temperature range
- Use of non-specified lubricants
- Use without adequate pressure relief valve
- Use in continuous operation excluding oil circulation lubrication systems.
- Use in areas with aggressive or corrosive materials (e.g. high ozone pollution)
- Use in areas with harmful radiation (e. g. ionising radiation)
- Feeding, forwarding, or storing hazardous substances and mixtures described in annex I part 2-5 of the CLP regulation (EG 1272/2008)
- Feeding, forwarding or storing gases, liquefied gases, dissolved gases, vapours or fluids whose vapour pressure exceeds normal atmospheric pressure (1013 mbar) by more than 0.5 bar at the maximum permissible operating temperature
- Use in an explosion protection zone

4.5 Painting of plastic parts prohibited

Painting of any plastic parts or seals of the described products is expressly prohibited. Remove or completely tape the relevant parts before painting the machine in which the product is installed.

4.6 Unauthorized modifications to the product

Unauthorised conversions or modifications may result in unintended effects on product safety and functionality. Therefore, any unauthorized conversions or modifications are expressly prohibited.

4.7 Prohibition of certain activities

Due to potential sources of faults that may not be visible, or due to legal regulations, the following activities may be carried out only by the manufacturer's specialists or persons authorised by the manufacturer:

- Opening the lubricant reservoir
- Safety valve adjustment, repair or removal

4.8 Compliance with other applicable documents

In addition to these instructions, the following documents must be observed by the respective target group:

- Operational instructions and approval rules
- Safety data sheet (SDS) of the lubricant used
- Project planning documents
- Instructions provided by the suppliers of purchased parts
- Any documents of other components required to set up the centralised lubrication system
- Other documents relevant for the integration of the product into the machine or system.

4.9 Notes concerning the type identification plate

The type identification plate indicates the type designation, order code and other key details of the machine. It locate inside of flowmeter (see page 35). To make sure no information is lost if the type identification plate becomes illegible, enter the details in this manual.

Type _____

Code _____

Date of manufacture _____

SKF Lubrication Solutions		SKF
TYYPPI TYPE	_____	
KOODI CODE	_____	
VALM. PVM. MANUF. DATE	_____	
	VALMISTAJA MANUFACTURER	Oy SKF Ab P.O. Box 80 FIN - 40951 MUURAME FINLAND

4.10 Notes concerning CE marking

The product bears the CE marking and conforms to the following European directives:

- EMC Directive 2014/30/EU
- RoHS II 2011/65/EU

4.11 Persons authorised to operate the device

4.11.1 Operators

A person who is qualified to carry out the functions and activities related to normal operation based on his or her training, knowledge and experience. This includes avoiding possible hazards that may arise during operation.

4.11.2 Mechanical specialist

Person with appropriate professional education, knowledge and experience to detect and avoid the mechanical hazards that may arise during transport, installation, commissioning, operation, maintenance, repair and disassembly.

4.11.3 Electrician

Person with appropriate professional education, knowledge and experience to detect and avoid electrical hazards.

4.11.4 Providing briefing for external technicians

Prior to commencing any activities, external technicians must be informed by the operator of the company's safety policies, the applicable accident prevention procedures and the functions of the machine, in which the product is installed, and of its protective devices.

4.11.5 Provision of personal protective equipment

The employer must provide to the operator suitable personal protective equipment for the location and purpose of the operation.

4.12 Operation

The following must be observed during commissioning and operation:

- Any safety-related information within this manual and the information within the referenced documents
- All laws and regulations that the operator must observe

4.12.1 Emergency stopping of the pump station

In case of an emergency, stop the pump station by:

- switching off the superior machine or system in which the pump station has been integrated.

4.12.2 Transport, installation, maintenance, malfunctions, repair, shutdown, disposal

- All relevant persons must be informed of the activity prior to starting any work. Observe the precautionary operational measures and work instructions.
- Transport the products with suitable transportation and hoisting equipment using suitable work methods.
- Maintenance and repair work can be subject to restrictions in low or high temperatures
- (e.g. changed flow properties of the lubricant). Therefore, where possible, try to carry out maintenance and repair work at room temperature.
- Before conducting any work, depressurize the product or superior machine into which the product will be integrated and secure it against unauthorised activation.
- Ensure through suitable measures that movable or detached parts are immobilized during the work and that no limbs can be caught in between if there are inadvertent movements.
- Assemble the product only outside of the operating range of moving parts, at an adequate distance from sources of heat or cold. Be careful not to damage other units in the machine or vehicle or impair their function during installation.
- Dry or cover wet, slippery surfaces.
- Cover hot or cold surfaces.
- Work on electrical components must be carried out by electrical specialists using voltage insulated tools only. Observe any waiting periods for discharging, if necessary.
- Make electrical connections only according to the information in the valid wiring diagram and taking the relevant regulations and the local connection conditions into account.
- Do not touch cables or electrical components with wet or damp hands.
- Fuses must not be bypassed. Replace fuses with same type and rating only.
- Undertake drilling at non-critical, nonload bearing parts only. It is preferable to use existing boreholes. Be careful not to damage lines and cables when drilling.
- Identify possible abrasion points. Protect the parts accordingly.

- All components used must be suitable for use in:
 - the system's maximum operating pressure, and
 - the system's minimum and maximum ambient temperature range.
- No parts of the centralised lubrication system may be subjected to twisting, shearing, or bending.
- Before using any parts, check them for contamination; clean if necessary.
- Lubricant lines should be primed with lubricant prior to installation. This makes it easier to bleed the system of air afterwards.
- Observe the specified tightening torques. Use a calibrated torque wrench.
- When working with heavy parts, use suitable lifting tools.
- Avoid mixing up dismantled parts or assembling parts in the wrong order by marking the parts accordingly.

4.13 Commissioning and daily start-up

Ensure that:

- All safety devices are completely installed and work properly.
- All connections are correctly connected.
- All parts have been correctly installed.
- All warning labels on the machine are complete, highly visible and undamaged.
- Replace illegible or missing warning labels without delay.

4.14 Cleaning

- There is a risk of fire and explosion when using flammable cleaning agents. Use only non-flammable cleaning agents suitable for the purpose.
- Do not use aggressive cleaning agents.
- Do not clean using a steam jet or pressure washer, as these may damage electrical components. Observe the IP protection class.
- Cleaning work on energised components may be carried out by electrical specialists only.
- Mark damp areas accordingly.

4.15 Residual risk

Residual risk	Possible in lifecycle stage	Prevention / remedy
Personal injury / material damage due to falling of raised parts	A, B, C, G, H, K	Keep unauthorised people away. Make sure no one remains under suspended parts or loads. Lift parts with suitable and tested lifting devices.
Personal injury / material damage due to tilting or falling of the product because of non-observance of the stated tightening torques	B, C, D, G	Observe the specified tightening torques. Fasten the product to components with adequate load-bearing capacities only. If no tightening torques are stated, apply tightening torques according to the screw size characteristics for 8.8 screws.
Personal injury / material damage due to electric shock from a damaged connection cable	B, C, D, E, F, G, H	Check that the connection cable is intact before using it for the first time and, after that, at regular intervals. Do not mount the cable to moving parts or at a friction point. If this cannot be avoided, use either spring coils or protective conduits depending on the circumstances.
Personal injury / damage to material due to spilled or leaked lubricant	B, C, D, F, G, H, K	Be careful when filling the reservoir and connecting or disconnecting lubricant feed lines. Always use suitable hydraulic screw connections and lubrication lines suitable for use in the stated pressures. Do not mount lubrication lines to moving parts or friction points. If this cannot be avoided, use either flexible hose lines, spring coils or protective conduits depending on the circumstances.
Lifecycle stages: A = transport, B = installation, C = commissioning, D = operation, E = cleaning, F = maintenance, G = fault, repair, H = decommissioning, K = disposal		

5 Delivery, returns and storage

5.1 Delivery

After receipt of the shipment, check the shipment for transport damage and completeness by comparing it to the shipping documents. Immediately report any damage suffered in transport to the forwarding agent. Keep the packaging material until any discrepancies are resolved. During in-house transport, ensure safe handling.

5.2 Returns

Clean all parts and pack them properly (i.e. following the regulations of the recipient country) before returning them. Protect the product against mechanical stress (knocks, impacts). Land, sea or air transport can be used for returns. Mark returns on the packaging as follows.



5.3 Storage

The products must be stored as follows:

- Store in a closed, dry, dust- and vibration- free place.
- Make sure there are no corrosive, aggressive materials at the place of storage (e. g. UV rays, ozone).
- Protect against pests and animals (insects, rodents, etc.).
- Can be stored in original product packaging.
- Shield the product against heat and cold.
- in case of high temperature fluctuations or high humidity, take adequate measures (e. g. heater) to prevent condensation.
- The product's acceptable storage temperature range is the same as its operating temperature (see Technical data).
-



Before using the products, inspect them for damage sustained in storage. This applies to parts made of plastic and rubber (embrittlement) as well as components primed with lubricant (ageing) in particular.

6 Lubricants

6.1 General information

Different lubricants are used in different applications. In order to fulfil their tasks, lubricants must fulfil various requirements to varying extents. The most important requirements for lubricants are:

- Reduction of abrasion and wear
- Corrosion protection
- Noise minimisation
- Protection against contamination and entry of foreign objects
- Cooling (primarily for oils)
- Longevity (physical/chemical stability)
- Compatibility with as wide range of materials as possible
- Meeting economic and ecological goals Immediately

6.2 Lubrication selection

SKF considers lubricants to be an element of system design. A suitable lubricant is selected when designing the machine and it forms the basis for centralised lubrication system planning.

The selection is made by the manufacturer/ operator of the machine, preferably together with the lubricant supplier based on a defined requirement profile.

If you have little or no experience with the selection of lubricants for centralised lubrication systems, please contact SKF.

If required, we will be glad to assist customers in selecting suitable components for feeding the selected lubricant and planning and designing their centralised lubrication system.

You will avoid possible costly downtimes caused by damage to your machine/system or the centralised lubrication system.

	NOTICE
	Only lubricants specified for the product may be used. Unsuitable lubricants may lead to product failure.

	NOTICE
	Do not mix lubricants. This may result in unforeseeable effects on the usability and therefore on the functionality of the centralised lubrication system.

	NOTICE
	Due to the multitude of possible additives, it is possible that individual lubricants, which according to the manufacturer's data sheets match the system's specification, are not in fact suitable for use in centralised lubrication systems (e.g. incompatibility between synthetic lubricants and materials). In order to avoid this, always use lubricants tested by SKF.

6.1 Material compatibility

Lubricants must generally be compatible with the following materials:

- steel, grey iron, brass, copper, aluminium
- NBR, FPM, ABS, PA, PU

6.2 Ageing of lubricants

After a prolonged downtime of the machine, the lubricant may no longer be suitable for use due to chemical or physical ageing and must therefore be inspected before the system is recommissioned. We recommend inspecting the lubricant already after a downtime of one week. If you suspect the lubricant is no longer suitable, replace it prior to recommissioning and, if necessary, perform the initial lubrication manually. It is possible for lubricants to be tested in the company's laboratory for their suitability in being pumped in centralised lubrication systems (e.g. no "bleeding"). Please contact SKF if you have further questions regarding lubricants. An overview of the lubricants tested by SKF is also available upon request.

7 General description

SKF Flowline monitor is an oil flow meter unit for controlling and measuring the flow rates of lubricants in oil circulation lubrication systems. The monitor consists of 1 to 10 flow meters depending on the model. The monitor has a local control unit with user's interface for displaying the flow rates and setting the measuring parameters. Each flow meter has a LED display for indicating the flow status and alarms. The control unit includes a common alarm output relay for connecting the flow alarm information to the customer's process control system.

The monitor can be equipped with a suitable optional module. The CAN-bus interface is for field bus communication with the customer's process control system and SKF Flowline software. The Relay-CAN module is for versatile common or individual alarm outputs and field bus communication. The mA-output module provides flow rates as 4-20mA analog signals.

8 Design



Figure 1 SKF Flowline monitor, main components

8.1 SKF Flowline monitor FL15

The SKF Flowline monitor FL15 is designed for 0,1 - 15 l/min flow range. FL15 monitor is comprised of a control unit and a number of flow meters connected to the control unit. There can be 2, 4, 6, 8 or 10 flow meters (fig. 2).



Figure 2 SKF Flowline monitor FL15 design, with six flow meters

8.2 SKF Flowline monitor FL50

The SKF Flowline monitor FL50 is designed for 15 - 50 l/min flow range. FL50 monitor is comprised of a control unit, one flow meter connected to the control unit and free flow tube. (fig. 3).



Figure 3 SKF Flowline monitor FL50 design

8.3 SKF Flowline monitor FL100

The SKF Flowline monitor FL100 is designed for 50 - 100 l/min flow range. FL100 monitor is comprised of a control unit and two flow meter connected to the control unit (→ fig. 4). There are two flow meters connected in parallel and sum flow is shown in the display.

- | | |
|--|--|
| | <p>The active right LEDs display the status of the sum flow of two flowmeters. You could adjust the sum flow from both flow valve.</p> |
|--|--|
- | | |
|--|--|
| | <p>Sensor's left LED's are not ON, only sensor's right LED's are ON.</p> |
|--|--|
- | | |
|--|--|
| | <p>The set alarm limits and the nominal flow are set for the sum flow.</p> |
|--|--|



Figure 4 SKF Flowline monitor FL100 design.

9 Operation

9.1 General

The measuring principle of the all Flowline monitor flow meters are to measure the rotation times of a sensitive lightweight turbine. A special inductive proximity switches in the flow meter senses the metal-coated wings of the turbine.

The control unit in the monitor reads the rotation times of the turbines from the flow meters and calculates the actual flow rate using a pre-programmed formula. The set viscosity grade and measured current temperature are used as parameters in calculation for best accuracy.

The flow meters communicate with the control unit using a bidirectional bus. The control unit reads rotation information from the flow meters and writes LED status to the flow meters according to calculated flow.

In FL50 the oil flows through two parallel flow tubes: main flow tube and side flow tube. Only the flow in side flow tube is measured. The side flow measuring result and main flow are converted to total flow rate in the control unit software. The side flow to be measured is separated from the main flow with an adjusting valve. The adjusting valve affects main flow and side flow synchronically.

In FL100 the oil flows through four parallel flow tubes: two main flow tubes and two side flow tube. Only the flows in side flow tubes are measured. These two side flow measuring results and two main flows are summed in the control unit software to generate the total flow

The monitor includes parameters for controlling the flow rate measurements. There are parameters that are individual for each flow meter (e.g. alarm limits) and parameters that are common for all flow meters in the monitor (e.g. oil viscosity grade). The parameters are set by the user's interface in the control unit. *Refer to section 8.6.*

A common alarm relay output is included in all monitors. If more versatile alarm outputs or communication are required, an optional plug-in CAN, Relay-CAN and mA-output modules are available.

The Relay-CAN module enables several alternatives for alarms, for example a separate alarm from each flow meter and several common alarm categories: low, high, pre-alarms and zero flow alarm. It and also CAN-module includes CAN-bus communication for remote monitoring of flow meters by the customer's process control system or by SKF Flowline software. Communication adapters from CAN-bus to several field buses like Profibus and Modbus are available. An optional analog mA-output module provides an analog interface, which is flexible to connect with other process equipment.





All Flowline monitors include a serial port for communicating with a PC. An optional SKF Flowline software is available which can be used for setting the measuring parameters and for monitoring the flows instead of the local user's interface.

9.2 LEDs in flow meters

Each flow meter has five LEDs which indicate the oil flow rate in relation to the set nominal flow rate and alarm limits. Refer to the section 9 Settings. The accepted flow rate range is indicated with three green LEDs. When the LED in the middle is lit, flow rate is close to the set nominal flow rate. The flow rate is in the pre-alarm range, when upper or lower green LED is lit. The pre-alarm limit is set as a percentage from the subtraction of nominal value and alarm limit. Default value for the pre-alarm limit is 40% (table 1).

When the flow rate goes below the low alarm limit value, a red LED is lit. When the flow rate exceeds the high alarm limit value, a yellow LED is lit.

Table 1 Flowmeter LEDs

Flow rate	LED	Description
> Set high alarm limit	 (yellow)	Alarm, High
>40% of Set high alarm limit-Set nominal flow	 (upper green)	Pre-alarm, High
<40% of Set high alarm limit-Set nominal flow >40% of Set nominal flow- Set low alarm limit	 (middle green)	Nominal flow
<40% of Set nominal flow- Set low alarm limit	 (lower green)	Pre-alarm, Low
< Set low alarm limit	 (red)	Alarm, Low



Nominal flow rate does not necessarily have to be in the middle of high/low alarm limits. The difference between the nominal and the low limit flow rate can be unequal to the difference between the nominal and high limit flow rate.



The percentage is adjustable by parameter PrS. See section 9.5.4 Pre-alarm limit.

9.3 User's interface in the control unit

The user's interface in the control unit can be used for monitoring lubrication point flow rates and lubrication oil temperature and for setting the measuring parameters for each flow meter and general parameters like oil viscosity and temperature unit.

The user's interface has two modes: measuring mode and setting mode. In measuring mode, the operator can browse and monitor measurement results and settings for lubrication points. In setting mode, the operator can adjust the settings, e.g. the alarm limit values. Setting mode requires a password, *refer to the section 9.2* The password is used to make sure that the settings are not adjusted accidentally or without permission.



Figure 5 Control unit

Table 2 Display modes

Display mode	Description
HIGH	Flow rate high alarm limit selected on display.
FLOW	Flow rate / Nominal flow rate selected on display.
LOW	Flow rate low alarm limit selected on display.



Table 3 Display units

Display unit	Description
L/MIN	Flow rate displayed in liters per minute.
PINT/MIN	Flow rate displayed in pints per minute.

Table 4 Function keys

Function key	Description
SET	When pressed momentarily, the set nominal flow of the selected flow meter is displayed for 5 seconds instead of the measured flow rate. When pressed 3 seconds, setting mode is entered. Setting mode requires password approval.
MODE	Select display mode.
< >	Select a flow meter to display in measuring mode. Change numeric values in setting mode.

Table 5 Display texts

Display text	Description
F1, F2...	Currently displayed flow meter; F1 = flow meter no. 1 etc.
°C	Temperature is displayed in Celsius.
°F	Temperature is displayed in Fahrenheit.
PPP	Enter password for setting mode.
ACC	Password correct → entering setting mode.
Err	Password incorrect → returning to measuring mode.
	Display in standby mode (3 decimal dots). If the monitor function keys are not used for 2 minutes and there are no active alarms, the display enters standby mode. Normal display is reactivated, when a key is pressed or an alarm is triggered.
	Displayed flow meter is not responding (3 hyphens). <i>Refer to the section 12 Troubleshooting.</i>
F ***	Sum flow. The display returns to show the sum flow automatically after one minute. *** Only in FL100.
FA & Fb ***	Two side flows is measured in FL 100. Measurements is combined to sum flow. The individual side flow can be displayed by pressing arrow to right. The display will automatically return to sum flow. *** Only in FL100.

9.4 Selecting a flow meter

Press the arrow keys to toggle between flow meters. Flow meter number is displayed in the control unit (e.g. "F2" = flow meter in position 2) and a LED is blinking in the flow meter that is selected on the display. After the last flow meter, oil temperature is displayed.

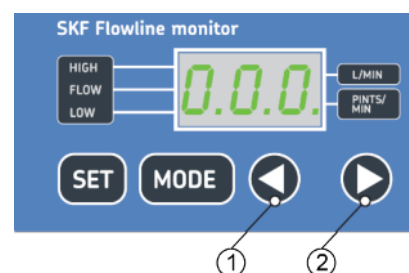

9.5 Selecting display mode

Press **MODE**-key to toggle between different display modes in the following order:

1. FLOW - flow rate
2. LOW - low flow alarm limit
3. HIGH - high flow alarm limit

Nominal flow rate settings can be displayed by pressing the SET-key momentarily in mode FLOW. The display returns to mode FLOW after 5 seconds.

The resolution of displayed flow rate depends on the current flow (→ table 6).

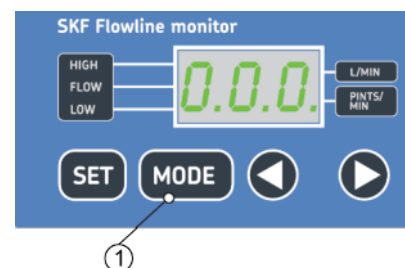

Table 6 Display resolution for flow rate

Flow rate (l/min or pints/min)	Display resolution (l/min or pints/min)
0...0,5	0,01
0,5...2,0	0,05
2,0...20,0	0,1
20,0...100,0	0,5

9.6 Flow rate adjustment

9.6.1 FL15 and FL50 flow meter adjustment

Oil flow rate is adjusted individually for each lubrication point. Flow valves are located in flow meters (→ **fig. 1**). The flow rate decreases when the flow valve knob is turned clockwise. The flow rate increases when the flow valve knob is turned counterclockwise.



Select the flow meter to be adjusted on display, then real flow could be monitored and the update rate of the flow meter LEDs is higher.



With low flow rates, there is a slight delay in displaying the flow rate values. The flow rate is updated on display only when the turbine wing goes past the sensor.

9.6.2 FL100 flow meter adjustment

The oil flow rate is adjusted with two separated flow valves, which are located in flow meter (→ **fig. 4**). The flow rate decreases when the flow valve knob is turned clockwise. The flow rate increases when the flow valve knob is turned counterclockwise.

The total flow in the FL100 is a sum of two flows FA and Fb. These flows can be monitored separately by pressing the arrow keys and switching the display between FA, Fb and the sum flow F. The individual flows FA and Fb should be adjusted to be close to half of the sum flow.

9.7 Start-up sequence

When the power is switched on, monitor starts with the startup sequence. All display segments LEDs are on, display unit and display mode LEDs are flashing. Flow meter LEDs are switched on in turns. The startup sequence takes 5-10 seconds. In the end of the sequence the CAN bus ID (e.g. 1) and the software version code of the control unit is displayed (e.g. code 3.11).

After start-up, flow meter LEDs indicate the current flow rates and the flow rate of the first flow meter is displayed in the user's interface.

10 Settings

10.1 General

The following **flow meter-specific** settings can be adjusted for controlling LEDs and alarm output:

- nominal flow rate
- low flow alarm limit
- high flow alarm limit
- alarm filtering
- flow meter shutdown and start-up

The following **monitor-specific** settings are common for all flow meters in the monitor:

- display units for oil flow and temperature
- oil viscosity grade
- flow meter type
- pre-alarm limit
- alarm mode of Flowline Relay-CAN module (visible only if add-on Flowline Relay-CAN module has been installed)
- CAN-bus ID-number

10.2 Entering the setting mode

Password is a **combination of numbers within the range of 000...999**. It must be entered before monitor settings can be changed.



The default password is 000. It can be changed only by SKF Flowline Software (optional).

- 1 Press **SET**-key for about 3 seconds, until text "**PPP**" appears on display.
- 2 Use the arrow keys to enter the first digit in the password and accept it with the **SET** key. The next number field is automatically activated.
- 3 Select and accept second and third digit as described in step 2 above.
- 4 If the entered password is valid, text "**ACC**" is displayed and monitor goes into setting mode. If the entered password is not valid, text "**Err**" is displayed and monitor goes back to measuring mode.

10.3 Exiting the setting mode

10.3.1 Saving parameters and exiting

Press **SET** key for approx. 3 seconds until message "END" is displayed. The monitor saves the changed parameters and goes back to measuring mode.

10.3.2 Exiting without saving parameters

If monitor is in setting mode and the keys have not been used for 2 minutes, the monitor goes back to measuring mode without saving any changes. Message "CAn" (Cancel) is displayed.

If the power is switched off while the monitor is in setting mode, the changes are not saved.

10.4 Flow meter-specific settings



In setting mode, all 10 flow meters of FL-15 are selectable on display, even if the monitor does not have the full number of flow meters. Only one flowmeter can be selected for type FL-50 and FL100. The nominal flow and alarm limits of the non-existing flow meters must be zero.

10.4.1 Nominal flow rate



The high alarm limit cannot be set lower than the nominal flow rate. The low alarm limit cannot be set higher than the nominal flow rate. It may be necessary to adjust the nominal flow rate first. Refer 10.4.2 Alarm limits



The nominal flow rate is the flow rate specified for the lubrication point.

Nominal flow rate is used to control the operation of the flow meter LEDs. Nominal flow rate refers to the flow rate level which the middle LED is set to indicate. *Refer to section 8.5 and Table 1.*

- 1 Press **SET**-key to select a flow meter. Flow meter LED blinks to indicate that the flow meter has been selected.
- 2 Press **MODE**-key, until signal **FLOW** is lit.
- 3 Use arrow keys to set the nominal flow rate.
- 1 Exit setting mode or adjust other settings.

10.4.2 Alarm limits

Flow meter alarm limits are set as follows:

- 1 Press **SET**-key to select a flow meter. Flow meter LED blinks to indicate that the flow meter has been selected.
- 2 Use **MODE**-key to select the parameter to be set. **LOW** indicates the low limit value and **HIGH** indicates the high limit value.
- 3 Use arrow keys to set the desired alarm limit values.
- 4 Exit setting mode or adjust other settings.

10.4.3 Alarm filtering

The parameter *Alarm filtering* (FIL) means alarm delay in seconds. If the flow rate of a flow meter goes back to normal level from alarm level within the set delay, the alarm relay output is not activated. The filtering parameter can be set within the range 000...999 s.

- 1 Use **SET**-key to select flow meter. Flow meter LED blinks to indicate that the flow meter has been selected.
- 2 Press **MODE**-key, until text **FIL** is displayed, toggling with the current set value.
- 3 Use arrow keys to set the desired filtering value.
- 4 Exit setting mode or adjust other settings.

Pre-alarm limit i.e. the limit when outermost green LEDs are lit can be set with the keyboard. The value of the parameter **PrS** is set as percentage from the subtraction of nominal value and alarm limit. The default value for the pre-alarm limit is 40%. The percentage is common to all flowmeters in the Monitor.

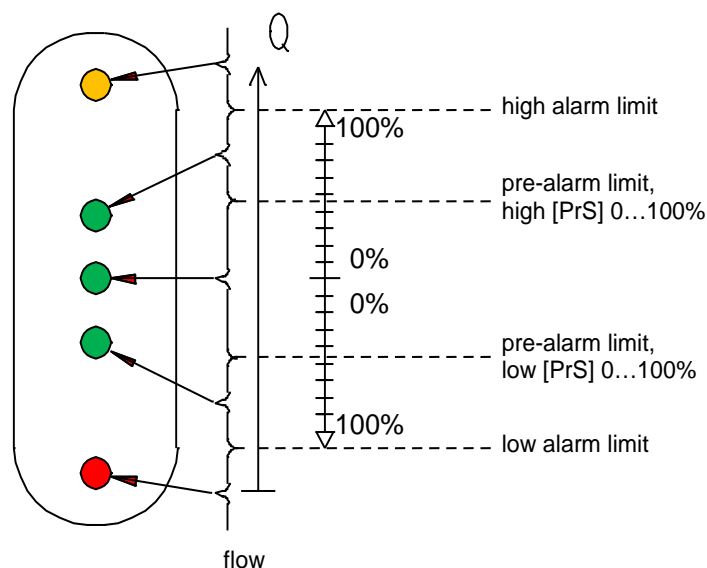

Figure 6 Pre-alarm limit

Example 1:

- Flowmeter's high alarm limit is set to 3 l/min.
- Nominal value is set to 1 l/min.
- Low alarm limit is set to 0,5 l/min.
- The percentage is set to 80%.

Pre-alarm limits are:

When the flow increases $1 \text{ l/min} + (3 \text{ l/min} - 1 \text{ l/min}) * 80\% = 2.6 \text{ l/min}$

When the flow decreases $1 \text{ l/min} + (0,5 \text{ l/min} - 1 \text{ l/min}) * 80\% = 0,6 \text{ l/min}$

Example 2:

- Nominal value is set to 1 l/min.
- Low alarm limit is set to 0,5 l/min.
- Lower pre-alarm value is 0,7 l/min.

Pre-alarm limit will be set to:

$$(1 \text{ l/min} - 0,7 \text{ l/min}) / (1 \text{ l/min} - 0,5 \text{ l/min}) * 100 = 60\%$$

10.4.4 Optional flow meter- specific settings

When the monitor has an optional circuit board, mA -output module, there will be two extra codes SCL and SCH visible for scaling the analog outputs. See chapter 14.3.2 mA -output module

10.4.5 Flow meter shutdown and start-up

A flow meter is shut down by setting **the nominal flow rate and both alarm limits to zero** (0.00). Flow meter LEDs are turned off, its measuring values cannot be displayed and the flow meter causes no alarm output. Shutting down a flow meter does not have any effect on the oil flow going through it.

A flow meter can be started-up by setting the nominal flow rate and the alarm limits to non-zero values.

10.5 Monitor-specific settings



Monitor-specific settings are common parameters for all flow meters in the monitor.

10.5.1 Display units for flow rate and temperature

Flow rate can be displayed in either liters per minute (L/MIN) or pints per minute (PINTS/MIN).

Temperature can be displayed either in degrees Celsius (°C) or degrees Fahrenheit (°F).

- 1 Press **SET**-key, until either °C or °F is displayed.
- 2 Select combination with **MODE**-key:
 - °C + L/MIN
 - °F + L/MIN
 - °C + PINTS/MIN
 - °F + PINTS/MIN

A LED is lit to indicate the flow rate unit and the display indicates the temperature unit.

- 3 Exit setting mode or adjust other settings.

10.5.2 Oil viscosity grade

The oil viscosity grade setting is the ISO VG grade of the oil in +40°C. This value is used with measured temperature for calculating the flow rate accurately.

- 1 Press **SET**-key, until text **OIL** is displayed, toggling with the current set value.
- 2 Use arrow keys to enter the new viscosity grade.
- 3 Exit setting mode or adjust other settings.

10.5.3 Flow meter type

- 1 Press **SET**-key, until text **TYP** is displayed, toggling with the current set value.
- 2 Use arrow keys to change the flow meter type. The numeric value displayed refers to the flow meter type. "15" refers to type FL15, "50" refers to type FL50 and "100" refers to type FL100
- 3 Exit setting mode or adjust other settings.

10.5.4 Pre-alarm limit

Pre-alarm limit, i.e. the limit when outermost green LED's are lit, can be set as a percentage from the subtraction of nominal value and alarm limit.

- 1 Press **SET**-key, until text **PrS** is displayed, toggling with the current set value.
- 2 Use arrow keys to set the percentage.
- 3 Exit setting mode or adjust other settings.

If optional Relay-CAN module is installed, pre-alarm limit parameter is used also to control the pre-alarm relays in alarm modes DL and DHL. See chapter 14.1 Relay-CAN module.

10.5.5 Alarm mode of Relay-CAN module

This setting is visible only, if optional Relay-CAN module has been installed.

One of the alarm mode codes is on display: **SL**, **SHL**, **DL**, **DHL**, **HL** or **C**.

Select the code by mode button. See chapter 14.1 Relay-CAN module.

10.5.6 CAN-bus ID-number

The ID-number setting is valid only, when optional CAN module or Relay-CAN module is installed and the monitor is connected to CAN-bus. If CAN bus is not used, the ID-number can be set to any value.

If the monitors are connected to CAN-bus, every monitor has a unique CAN ID-number 1...100 for communication.

More information in SKF *Flowline monitor CAN interface manual*.

11 Installation

11.1 Mechanical installation

11.1.1 Monitor dimensions



Free space is required on the right side and above of the monitor for the motherboard and flowtube installation (Figure 18))



Figure 7 Monitor dimensions FL15 and FL50

Type	L [mm]
FL15-02	226
FL15-04	324
FL15-06	422
FL15-08	520
FL15-10	618
FL50-01	226



Figure 8 Monitor dimensions FL100

Type	L [mm]	D [mm]
FL100-01-R	324	116
FL100-01-U	324	124

11.1.2 Pipe connections

Table 7 Pipe connections, FL15

Connection	Flowmeter type	Type and size
A = Oil input	FL15-XX-R FL15-XX-U	G 1" NPT 1"
B = Oil output	FL15-XX-R FL15-XX-U	G 1/2" NPT 1/2"

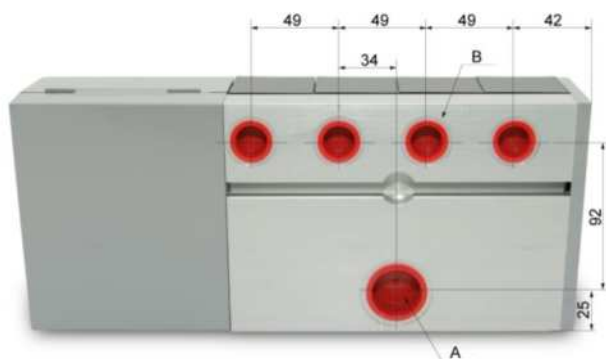

Figure 9 Pipe connections, FL15

Table 8 Pipe connections, FL50

Connection	Flowmeter type	Type and size
A = Oil input	FL50-01-R FL50-01-U	G 1" NPT 1"
B = Oil output	FL50-01-R FL50-01-U	G 1" NPT 1"

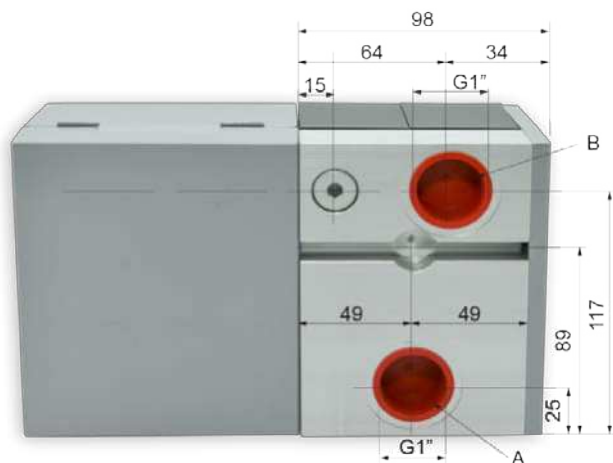

Figure 8 Pipe connections, FL50

Table 9 Pipe connections standard, FL100 comes with one connection block

Connection	Flowmeter type	Type and size
A = Oil input	FL100-01-R FL100-01-U	2 x G 1" 2 x NPT 1"
B = Oil output	FL100-01-R FL100-01-U	1 x G 1 1/4" 1 x NPT 1 1/4"

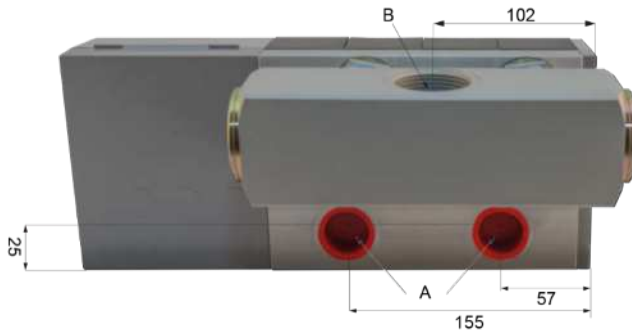

Figure 9 Pipe connections standard, with connection block FL100

Connection	Flowmeter type	Type and size
A = Oil input	FL100-01-R FL100-01-U	2 x G 1" 2 x NPT 1"
B = Oil output	FL100-01-R FL100-01-U	2 x G 1" 2 x NPT 1"

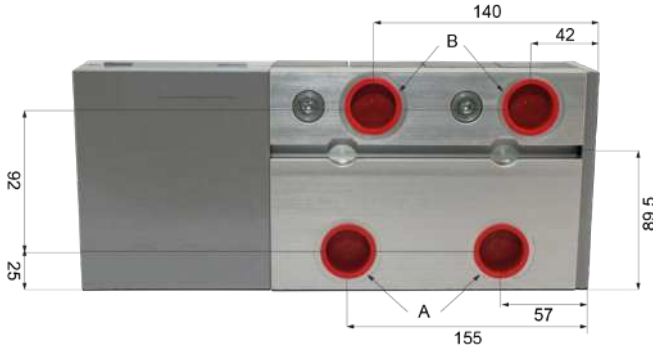

Figure 10 Pipe connections, options without connection block.



For FL100 is available additional connection blocks 13120180 CONNECTION BLOCK G1 1/4 and 13120182 CONNECTION BLOCK NPT 1 1/4 (Figure 11)



Figure 11 FL100 with two connection block.

11.2 Electrical connections

The terminals for external electrical connections locate in the control unit. The group electronics board is equipped with plug-in screw connectors for the electrical cables.

Connections within monitor between flow meters and control unit are performed through a motherboard. Control unit is connected to the motherboard with a flat cable. Flow meters are connected to motherboard as plug-in units.

The figures below illustrate locations of the components in the control unit. (→ **Figure 12**). The figures also show the cover opened as during normal maintenance operation.

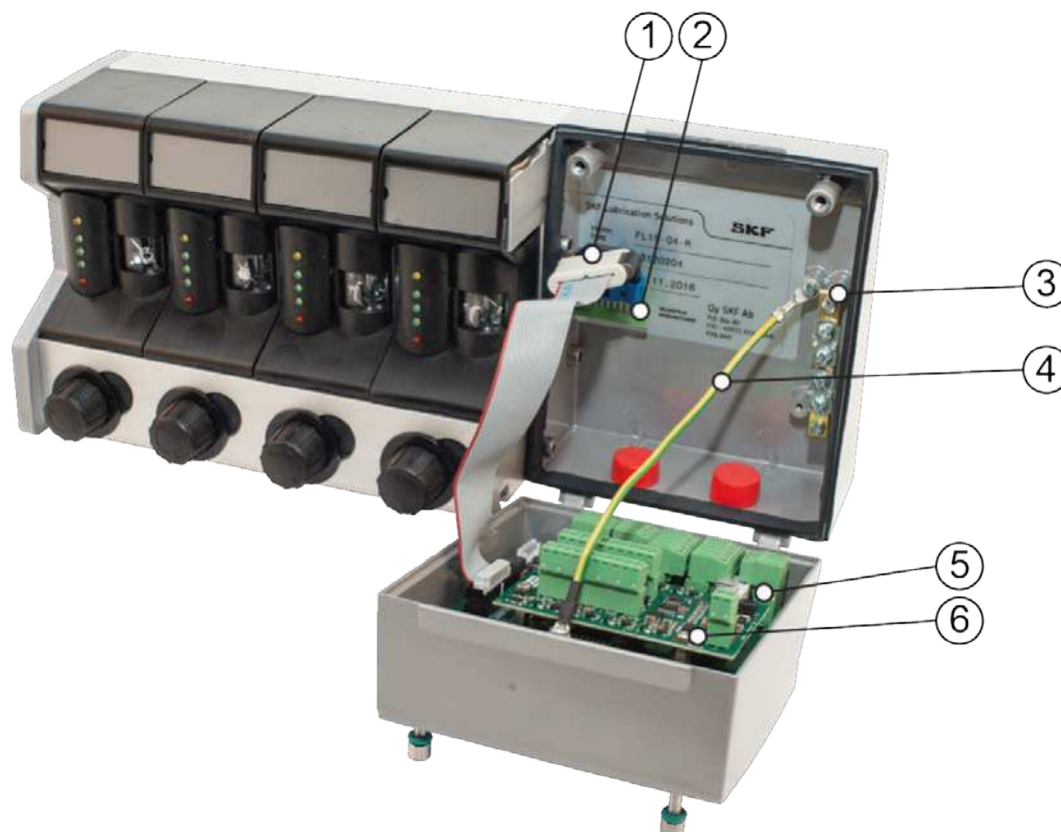

Figure 12 Control unit connections

1. Flat cable
2. Motherboard
3. TE-bar, for connecting the shield of the CAN cable
4. Grounding wire, for grounding the cover of the display unit
5. Group electronics
6. Optional interface modules (mA, Relay-CAN and CAN)

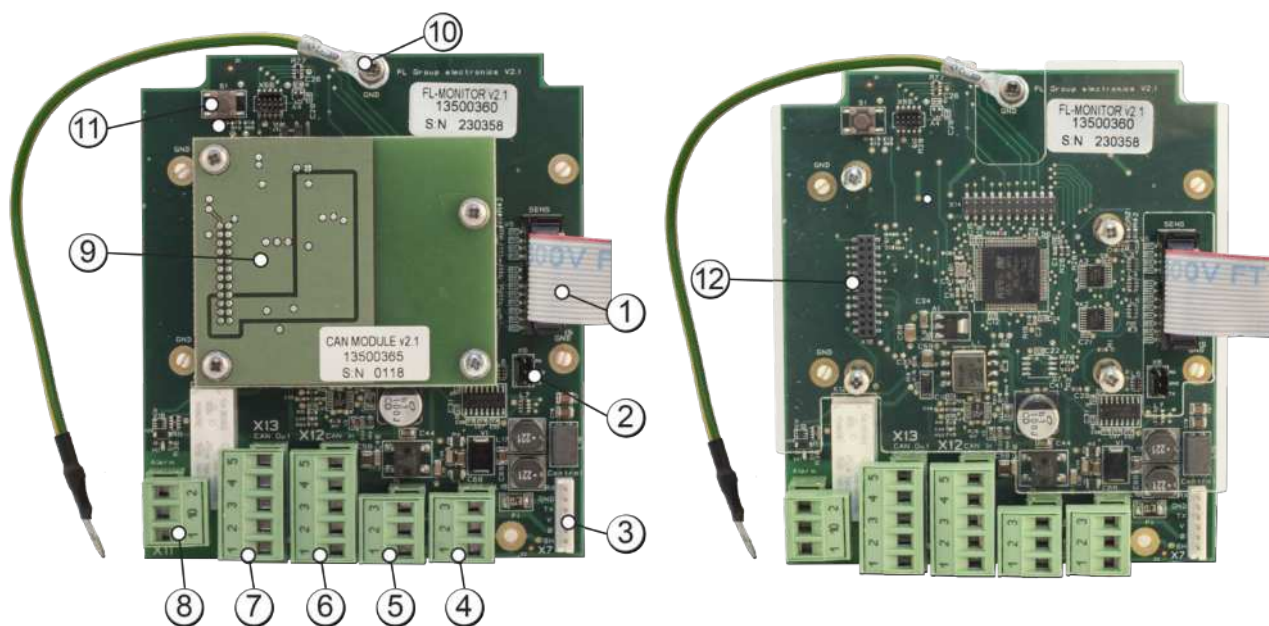



Figure 13 Group electronics connections

Nro	Description	Connector	Type
1.	Flat cable, flow sensor connection	X5	Sens
2.	RS232 port connector for a local PC	X6	
3.	Auxiliary connector for special applications	X7	Control
4.	24V AC/DC power supply connector(in)	X9	PWR in
5.	24V AC/DC power supply connector (out to next monitor)	X10	PWR out
6.	CAN cable connector (in)	X12	CAN in
7.	CAN cable connector (out)	X13	CAN out
8.	Alarm output connector	X11	Alarm
9.	Optional Relay-CAN module, mA-module or CAN-module.	screw	
10.	Grounding wire, for grounding the cover of the display unit	screw	
11.	Button for firmware update	S1	
12.	Connector for optional modules	X18	

Table 10 Electrical connections

Connector	Description	Terminals	
24V AC/DC power supply connector Pwr In	24 VDC (20...36VDC) or 24 VAC (-20...+5%). Monitor power consumption: 5 W. Fuse: Resettable polymer fuse 750mA	X9: 1	Frame ground, do not connect
		X9: 2	AC or –DC
		X9: 3	AC or +DC
24V AC/DC power supply connector (out to next monitor) Pwr out	Monitor power supply chaining option.	X10:1	Internally connected to X9: 1
		X10:2	Internally connected to X9: 2
		X10:3	Internally connected to X9: 3
Alarm output connector	Potential-free connection for connecting monitor alarms to process control system. Alarm is active, when one or more flow meters are in alarm mode or if the system has detected a defective flow meter. Contact open in alarm mode and when monitor is not powered. Max load: 30 VDC/1A, 120VAC/1A, resistive load	X11: 1	Alarm output
		X11: 2	Alarm output
		X11: 10	Not connected
CAN cable connector X12, CAN In, X13, CAN Out	Interface for SKF Flowline Hub or process control system CAN 2.0A (Control Area Network) data transfer protocol. Requires optional CAN or Relay CAN module. <i>See also SKF Flowline monitor CAN interface manual.</i>	X12,X13: 1	CAN GND
		X12,X13: 2	CAN LO
		X12,X13: 3	CAN HI
		X12,X13: 4-5	Not connected
Auxiliary connector	Used only in special applications	X7	
RS232 port connector for a local PC	RS232-compliant connection. Local connection to PC with SKF Flowline Software. Data transfer distance: max. 10 m. A cable with D9 connector, length 10 m, is available (SKF code 13772010).	X6	
Relay-CAN module (option)	Versatile Relay and CAN-bus communication interface board for Flowline monitor	<i>See paragraph 13.1 & 13.2</i>	
CAN module (option)	CAN-bus communication interface board for Flowline monitor	<i>See paragraph 13.2</i>	
mA-output module (option)	Analog output interface board for Flowline monitor	<i>See paragraph 13.3</i>	

12 Maintenance

	<p>WARNING</p> <p>Before disassembling or removing the monitor, the monitor must be disconnected from its power source and all lubrication point oil connections to the monitor must be closed.</p>
	<p>WARNING</p> <p>Before and after disassembling or removing the monitor make sure that the monitor is not hot and/or environment is clean.</p>

	<p>NOTICE</p> <p>Do not use any solvent to wash flowmeters. Solvents may weaken or damage certain parts of flowmeters.</p>
--	---

	<p>NOTICE</p> <p>All electrical components must be protected against oil splashes.</p>
--	---

	<p>Spare parts, refer to section 16</p>
---	---

	<p>You could find maintenance videos from http://www.skfmuurame.fi/videos/</p>
---	---

12.1.1 Removing and reinstalling sensor

Before flowmeter cover is removed, the sensor must first be removed. Twist gently with a screwdriver at the right-side upper edge of the sensor.

	<p>Arrow head in the sensor indicates the point where pressure can be applied. Applying pressure elsewhere may damage the sensor.</p>
---	---



Figure 14 Removing sensor. Spare part: Sensor unit (*Refer to section 16 Spare parts*).

When the first sensor is reinstalled, make sure that the motherboard connectors inside the frame of the monitor are in their correct positions in relation to the connectors in the sensor. Push sensor manually to its correct position.

12.1.2 Removing and reinstalling flowmeter cover

Before flowmeter cover is removed, the sensor must first be removed as described above.

- 1 Twist carefully with a screwdriver, first detaching the bottom of the cover from the monitor body.
- 2 Detach the top of the cover.

Cover can be reinstalled by repeating the steps in reverse order.



Figure 15 Removing flowmeter cover

FL15, FL50 and FL100. (Refer to section 16 Spare parts).

12.1.3 Removing and reinstalling flow tube assembly



Close all flow valves while replacing a flow tube assembly

Remove flow tube assembly according to following instructions (numbers refer to part numbers in Figure 16).

- 1 Remove sensor. (part 1)
- 2 Remove flowmeter cover. (part 2)
- 3 Open hexagonal plug. (part 9)



WARNING

Make sure that the spring (pos.7) that applies force to the turbine mechanics does not fling the parts loose.

- 4 Remove spring, upper flange and O-ring from the drillings of the monitor body. (parts 6,7,8)
 - 5 Remove flow tube assembly and O-ring. (parts 4,5)
 - 6 Remove laminator. (part 3)
 - 7 Double check the condition of non-return valve. It is locating in outlet connection of flow meter (part 10)
- Replace required parts and reinstall the flow tube assembly in reverse order.



Make sure that the visible groove in the flow tube is at the lower end of the tube (see arrow in the figure 16).



Figure 16 Replacing a flowtube assembly and visible groove

Spare parts: FL15-KIT-FLOWTUBE-A 13120472, FL50-KIT-FLOWTUBE-A 13120477 and FL NON-RETURN VALVE 13771880 (Refer to section 16 Spare parts).

12.1.4 Removing and reinstalling flow valve



Close oil feed to the group and all flow valves of the group while replacing a flow valve.

Remove flow valve according to following instructions (numbers refer to part numbers in Figure 17).

- 1 Remove flow valve knob. (part 2)
- 2 Remove flow valve wheel. (part 1)
- 3 Remove flow valve flange. (part 4)
- 4 Pull flow valve out of its drillings. (part 3)

Replace required parts and reinstall the flow valve in reverse order.



Figure 17 Replacing a flow valve

Spare parts: FL15-KIT-VALVE-A 13120480, FL50-KIT-VALVE 13120485 and 13120487 FL-KIT-KNOB (Refer to section 16 Spare parts).

12.1.5 Removing and reinstalling motherboard

Remove all sensors and the flat cable before removing the motherboard.

Pull motherboard out of its slot as far as you can and maneuver it gently out of its position by twisting it slightly.

The maximal twist angle is 60°. See the figure below.

Reinstall the motherboard by repeating the above steps in reverse order.



Figure 18 Removing motherboard

Spare parts: FL-Motherboard (Refer to section 16 Spare parts).

12.1.6 Installing optional Relay-CAN, mA-output or CAN module

Remove the four screws (A) for the add-on board from Group electronics. If there is a plastic shield fixed with those screws, remove it. The shield cannot be used with the add-on board.

There is a 22 pin connector (B) on the left side of Relay-CAN, mA-output or CAN module.

Be careful to plug in the connector pins to the female connector (X18) on the Group electronics board.

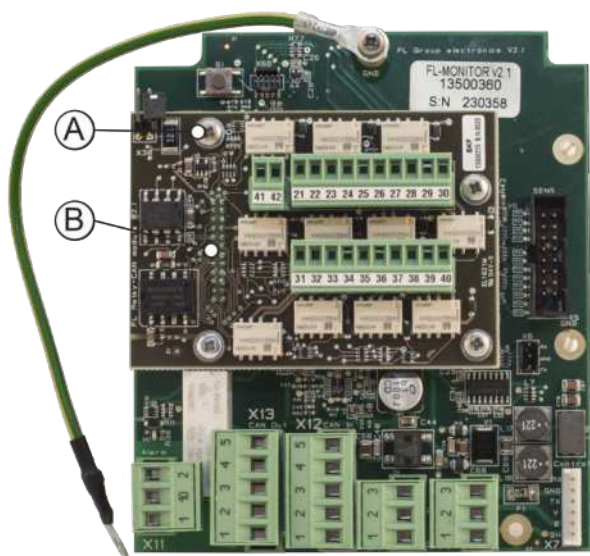

Figure 19 Attach the four fixing screws (A) to install the optional module.

13 Technical specifications

Table 11 SKF Flowline monitor, technical specifications

Description	Value
Operating temperature	0...+65°C (+32...+150°F)
Resettable polymer fuse	750mA
Operating voltage	20...36 VDC 24 VAC (-20%...+5%)
Operating current	150mA max.
Alarm output	Potential free contact Max load: 30 VDC/1A, 120VAC/1A, resistive load
* Oil viscosity	32 – 1000 cSt, 40°C
Protection classification	IP65
Dimensions	226...618 x 106 x 150 mm (w x d x h)
FL15 oil input connection, threading FL50 oil input connection, threading FL100 oil input connection, threading	BSPP G1 (EN ISO 228-1) or NPT 1 BSPP G1 (EN ISO 228-1) or NPT 1 Standard 2 x G1 (EN ISO 228-1) or 2 x NPT 1 Or with connection block 1 x G1 ¼ or 1 x NPT 1 ¼
FL15 oil output connection, threading FL50 oil output connection, threading FL100 oil output connection, threading	BSPP G1/2 (EN ISO 228-1) or NPT 1/2 BSPP G1 (EN ISO 228-1) or NPT 1 BSPP G1 ¼ or 1 x NPT 1 ¼ (connection block standard) OR BSPP 2 x G1 (EN ISO 228-1) or 2 x NPT 1
Oil flow range FL15 monitor ** Oil flow range, FL50 monitor ** Oil flow range, FL100 monitor	0,1- 15 l/min, 15 – 50 l/min 50 – 100 l/min
Pressure loss over flowmeter	FL15, 150 cSt, 15l/min max ΔP = 1 bar / 14,5 Psi FL50, 150 cSt, 50 l/min max ΔP = 1 bar / 14,5 Psi FL100, 150 cSt, 100 l/min max ΔP = 1 bar / 14,5 Psi
Highest allowed input pressure	10 bar /145 Psi
Accuracy ***	FL-15: +-5% of reading FL 50 & FL 100: +-5% of reading

* for low and high flows and viscosities, contact to SKF reseller to ensure flow meter proper operation

** FL50 and FL100 can also be used in the flow range below minimum, 15l/min for FL50 and 50 l/min for FL100, but measuring accuracy is not sufficient for the low volumes.

*** Operating oil viscosity 100...1000 cSt

Table 12 Symbols

FLXX-YY-Z-WWW	Abbreviation	Description
FL:	FL	SKF Flowline monitor
XX:	15	Flowmeter type, FL15
	50	Flowmeter type, FL50
	100	Flowmeter type, FL100
YY:	01	Monitor FL50 or FL100 single flowmeter
	02	Monitor FL15 with 2 pcs flowmeters
	04	Monitor FL15 with 4 pcs flowmeters
	06	Monitor FL15 with 6 pcs flowmeters
	08	Monitor FL15 with 8 pcs flowmeters
	10	Monitor FL15 with 10 pcs flowmeters
Z:	R	Connections, G-female threads
	U	Connections, NPT-female threads
WWW:	RCM	Relay and CAN bus interface module (OPTIONAL)
	CAN	CAN bus interface module (OPTIONAL)
	mA	mA-output module (OPTIONAL)

Example:

FL15-06-R

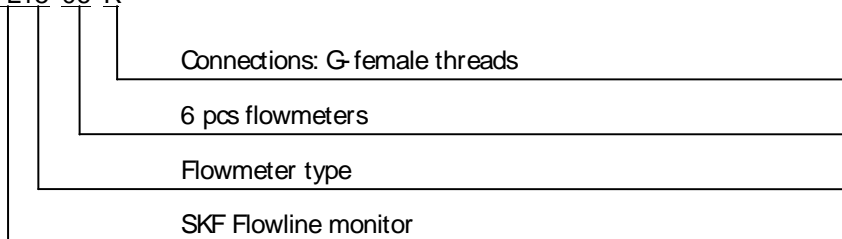

14 Optional modules

14.1 Relay-CAN module overall

FL Relay-CAN module is a plug-in interface board for SKF Flowline monitor.

Features

- Individual alarms of flowmeters or specified common alarms, depending on the selected mode.
- CAN bus communication *See part 13.2 CAN Module*

The module is compatible with Flowline monitor models FL-15, FL-50 and FL-100.

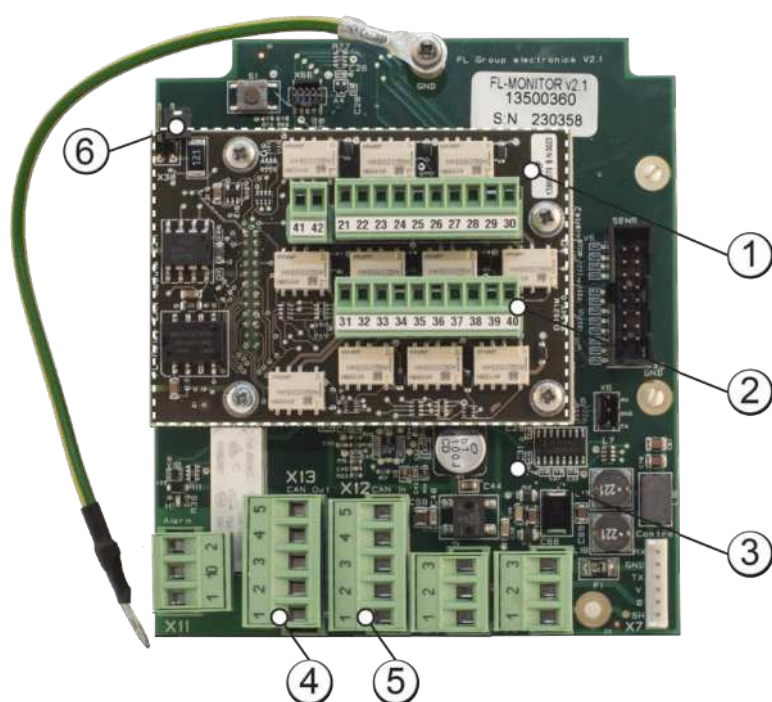

Figure 20 FL Group electronics with FL Relay-CAN board inserted

1. FL Relay – CAN module
2. Terminals for relay output
3. FL Group electronics module
4. Connector for CAN bus, X13 CAN out
5. Connector for CAN bus, X12 CAN in
6. CAN-bus termination resistor jumper

14.1.1 Relay general description

The module contains 11 relays that can be configured to versatile flow alarm modes. The relay functions are configured using the local user interface of SKF Flowline monitor.

14.1.2 Operation of alarm relays

The operation of relays 1 to 10 can be configured in following ways:

- Individual alarm relay for each flowmeter in SKF Flowline monitor (configuration **SHL** and **SL**)
- Two individual alarm relays for each flowmeter in SKF Flowline monitor (configurations **DHL**, **DL** and **HL**)
- Common alarm relays for all flowmeters in SKF Flowline monitor (configuration **C**)

Relay 11 indicates faults in electronics. It is independent from the selected configuration.

Configuration is selected by the user interface of the Monitor See paragraph 9.5.5 *Alarm mode of Relay-CAN module*.

All relays have potential free contact. **Relay alarm state is open contact.**

When Flowline monitor is in power off state, the relays # 1 ...10 are contact closed and relay #11 is contact open.

Relay max. contact rating: 50VDC/ 0,5A, resistive load

Connectors for relay outputs: Screw connectors, 3.81 mm spacing for wires 0,14 to 1.5 mm².

Individual alarms (**SHL**, **SL**)

With these operation modes every flowmeter in the Monitor has a relay, which operates as an alarm relay. If required, high level alarm can be disconnected. All alarms in the group have the same logical operation.

Configurations choices are:

SL, Separate alarm low, flowmeter specific low level alarm.

High level alarm does not affect operation of the relay.

SHL, Separate alarm high and low, flowmeter specific high and low level alarm.

Both alarm types affect operation of the relay.

See chapter 10.4.3 *Alarm filtering*.

Alarm delay is set by FIL-value in the same way as for the common alarm relay on Monitor group electronics.

Table 13 Individual alarms (SHL, SL), relay operation and screw terminals

Relay nr	Operation	Screw terminals
1	Flowmeter nr 1 alarm relay	21, 22
2	Flowmeter nr 2 alarm relay	23, 24
3	Flowmeter nr 3 alarm relay	25, 26
4	Flowmeter nr 4 alarm relay	27, 28
5	Flowmeter nr 5 alarm relay	29, 30
6	Flowmeter nr 6 alarm relay	31, 32
7	Flowmeter nr 7 alarm relay	33, 34
8	Flowmeter nr 8 alarm relay	35, 36
9	Flowmeter nr 9 alarm relay	37, 38
10	Flowmeter nr 10 alarm relay	39, 40

Individual alarms (DHL, DL and HL)

With these operation modes every flowmeter in the Monitor has two (2) relays. Because the maximum amount of relays is 10, this operation mode can be used only if there are 1 to 5 flowmeters in a SKF Flowline monitor FL15.

Individual alarms (DHL and DL)

One of the flowmeter specific relays operates as an alarm relay as in configurations **SHL** and **SL**. Alarm delay is set by FIL-value in the same way as for the common alarm relay on group electronics.

See chapter *10.4.3 Alarm filtering*

The other relay operates as pre-alarm relay. Relay is in alarm mode when the flowmeter is out of the nominal value range i.e. the green led in the middle of the sensor is off. Setting the nominal value range, see paragraphs *9.5.4 Pre-alarm limit*. FIL-value does not affect this pre-alarm relay.

Configurations:

DL, Double alarm low, flowmeter specific low level alarm and pre-alarm for decrease of the flow.

DHL, Double alarm high and low, flowmeter specific low and high level alarm and pre-alarm for increase and decrease of the flow.

Table 14 Individual alarms (DHL, DL), relay operation and screw terminals

Relay nr	Operation	Screw terminals
1	Flowmeter nr 1 alarm relay	21, 22
2	Pre-alarm relay of flowmeter nr 1	23, 24
3	Flowmeter nr 2 alarm relay	25, 26
4	Pre-alarm relay of flowmeter nr 2	27, 28
5	Alarm relay of flowmeter nr 3	29, 30
6	Pre-alarm relay of flowmeter nr 3	31, 32
7	Alarm relay of flowmeter nr 4	33, 34
8	Pre-alarm relay of flowmeter nr 4	35, 36
9	Alarm relay of flowmeter nr 5	37, 38
10	Pre-alarm relay of flowmeter nr 5	39, 40

Individual alarms (HL)

One of the flowmeter specific relays operates as a low level alarm relay and the other one as a high level alarm relay. Alarm delay is set by FIL-value in the same way as for the common alarm relay on group electronics.

FIL-value affects both alarms the same way.

Table 15 Individual alarm (HL), relay operation and screw terminals

Relay nr	Operation	Screw terminals
1	Low level alarm relay of flowmeter nr 1	21, 22
2	High level alarm relay of flowmeter nr 1	23, 24
3	Low level alarm relay of flowmeter nr 2	25, 26
4	High level alarm relay of flowmeter nr 2	27, 28
5	Low level alarm relay of flowmeter nr 3	29, 30
6	High level alarm relay of flowmeter nr 3	31, 32
7	Low level alarm relay of flowmeter nr 4	33, 34
8	High level alarm relay of flowmeter nr 4	35, 36
9	Low level alarm relay of flowmeter nr 5	37, 38
10	High level alarm relay of flowmeter nr 5	39, 40

Common alarms (C)

Relays are common alarm relays. Relay is in alarm mode when one or several flowmeters of the Monitor are in alarm mode. Every relay has a fixed operation mode.

Table 16 Common alarms (C), relay operation and screw terminals

Relay nr	Operation	Screw terminals	Description
1	Low and high level alarm	21, 22	Relay is in alarm mode when one or several flowmeters are in alarm mode i.e. yellow or red led is lit.
2	Pre-alarm, low and high	23, 24	Relay is in alarm mode when one or several flowmeters are out of the nominal value range i.e. the green led in the middle is off.
3	Low level alarm	25, 26	Relay is in alarm mode, when one or several flowmeters are in low level alarm mode i.e. red led is lit.
4	High level alarm	27, 28	Relay is in alarm mode, when one or several flowmeters are in high level alarm mode i.e. yellow led is lit.
5	Pre-alarm, decreasing	29, 30	Relay is in alarm mode when the flow of one or several flowmeters has decreased from the nominal value i.e. lower green or red led is lit.
6	Pre-alarm, increasing	31, 32	Relay is in alarm mode when the flow of one or several flowmeters has increased from the nominal value i.e. higher green or yellow led is lit.
7	No flow -alarm	33, 34	Relay is in alarm mode when the flow of one or several flowmeters is less than 0,05 l/min.
8	not in use	35, 36	not in use
9	not in use	37, 38	not in use
10	not in use	39, 40	not in use

Alarm delay is set by FIL-values in the same way as for the common alarm relay on Group electronics. FIL-value can be set individually for each flowmeter. FIL-value does not affect on pre-alarms.

Setting of pre-alarm limits, see paragraphs 9.5.4 *Pre-alarm limit*.

Note! In mode C, when fault relay nr 11 is in alarm mode, also relays 1 to 7 are in alarm mode despite what the flow rate is.

Fault message

Relay nr 11 on the module indicates faults the Monitor has detected. This relay helps in detecting fault alarms from flow alarms. For example, when power failure occurs, flow status cannot be determined, but relay nr 11 is then in alarm state.

Possible faults:

Power failure

Fault detected by fault diagnostic of Monitor electronics, for example "flow sensor does not respond".

Fault in temperature sensor

In operation mode C all other relays go to alarm mode, too, when a fault is detected. In other operation modes the relays which belong to the defective flowmeter go to alarm mode in addition to the fault relay.

Table 17 Fault message, screw terminals

Relay nr	Operation	Screw terminals
11	Fault message	41, 42

14.2 CAN module

The CAN bus interface is used for connecting the monitors to remote control and monitoring systems. Various fieldbus alternatives are available for connecting to customer's DCS systems by using standard CAN/Fieldbus gateways:

- Modbus RTU
- Modbus TCP
- Profibus
- Ethernet/IP

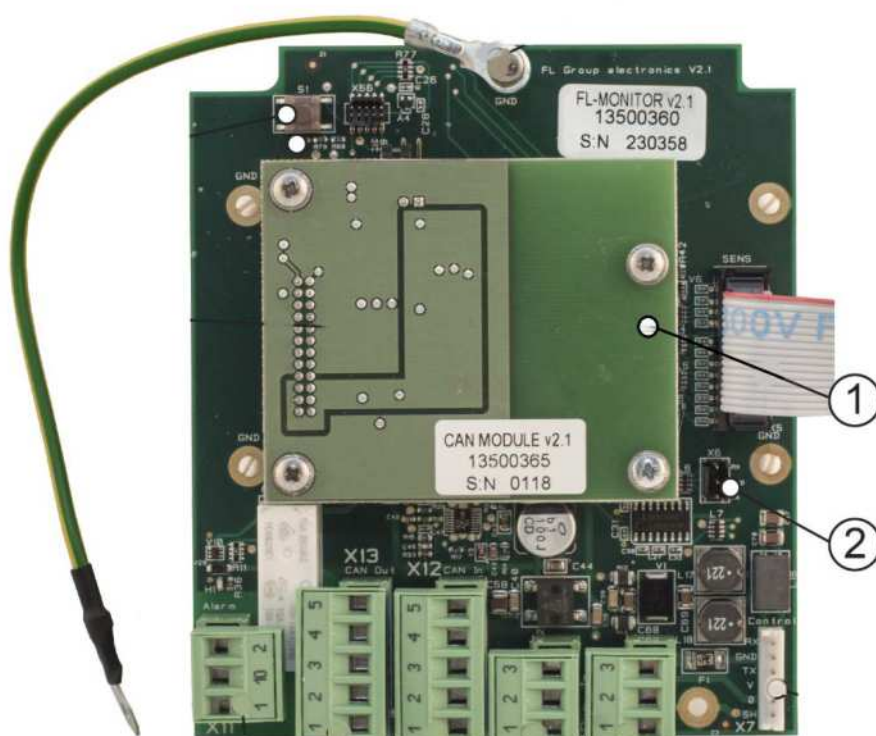

Figure 21 General, 1: CAN- module, 2: FL Group electronics

SKF Flowline Hub and SKF Flowline software can be used with CAN bus interface for building a stand -alone PC based control and monitoring system.

The features and the applications of the CAN bus interface of Flowline monitor can be found in: **SKF Flowline monitor CAN-interface manual.**

All CAN functions that are available with FL CAN module are also available with **FL Relay-CAN** module.

Main features of CAN bus:

- protocol CAN2.0A
- bit rate 50kb/s

14.2.1 CAN bus connectors

In Flowline monitor CAN bus screw terminals locate in connectors X12 and X13.

The connectors are connected in parallel for chaining the bus from one monitor to the next one.

X12 is marked CAN In and X13 is marked CAN Out but electrically they are connected parallel and are equal.

Table 18 Bus connectors

X12, X13:1	CAN_GND
X12, X13:2	CAN_L
X12, X13:3	CAN_H

TE-bar is for connecting the cable shields.



Figure 22 Connectors for CAN bus in monitor, 1: X12, 2: X13, 3: TE-Bar

14.3 mA-output module

FL mA module is a plug-in interface board for SKF Flowline monitor. It has ten channels of flow rate dependent, scalable, 4- 20 mA analog output for each flowmeter in the monitor.

The module is compatible with Flowline monitor models FL-15, FL-50 and FL-100.

The FL mA module is installed in the optional board slot of the FL Group electronics.

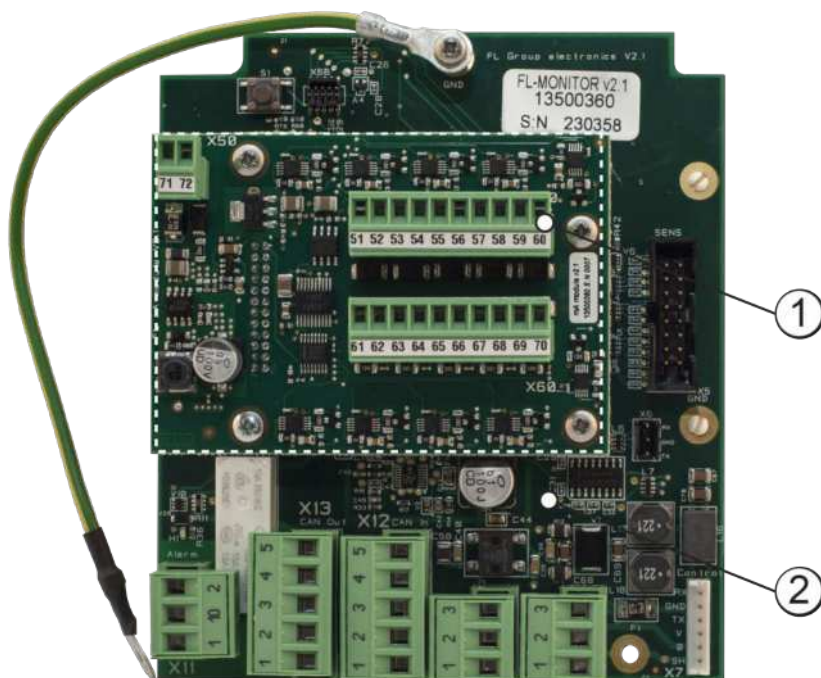

Figure 23 General, 1: FL mA output module, 2: FL Group electronics

14.3.1 Features

- Compatible with all models of Flowline monitor FL-15, FL-50 and FL-100.
- Each output is scalable independently by the user interface of Flowline monitor.
- Current outputs are active type. Each output supplies current to the customer's measuring circuit.
- The module has a separate 24VDC power supply input for current loops
- The power supply and current loops has galvanic isolation from the supply voltage of Flowline monitor
- It can be supplied from:
 - ➔ 24V DC power supply voltage of the monitor (**no galvanic isolation**)
 - ➔ a separate 24V DC power supply (**with galvanic isolation**)
- Allowed loop resistance 0...500ohm
- Output resolution 1/1000 of the full scale

14.3.2 Scaling of the analog outputs

When the module is installed in the monitor, two new parameters appear for each flowmeter in the setting mode:

SCL (scale low) The flow rate for 4mA output

SCH (scale high) The flow rate for 20mA output

The current output / flow rate relationship is linear between the set limit values.

The default settings are

- SCL=0 l/min, SCH=15 l/min (31.7pints/min) for FL-15
- SCL=0 l/min, SCH=50 l/min (105.7pints/min) for FL-50
- SCL=0 l/min, SCH=100 l/min (211.3pint/min) for FL-100.
- See chapter 10.4 *Flow meter specific settings*

Flow values beyond scaled values:

- Flows > SCH: mA output is linear up to 20,5mA,

- Flows < SCL: mA output is linear down to 3,5mA,

Fault indication:

If flowline monitor indicates fault in flow measurement (dashes - - - on display) the current output is 3,5mA.

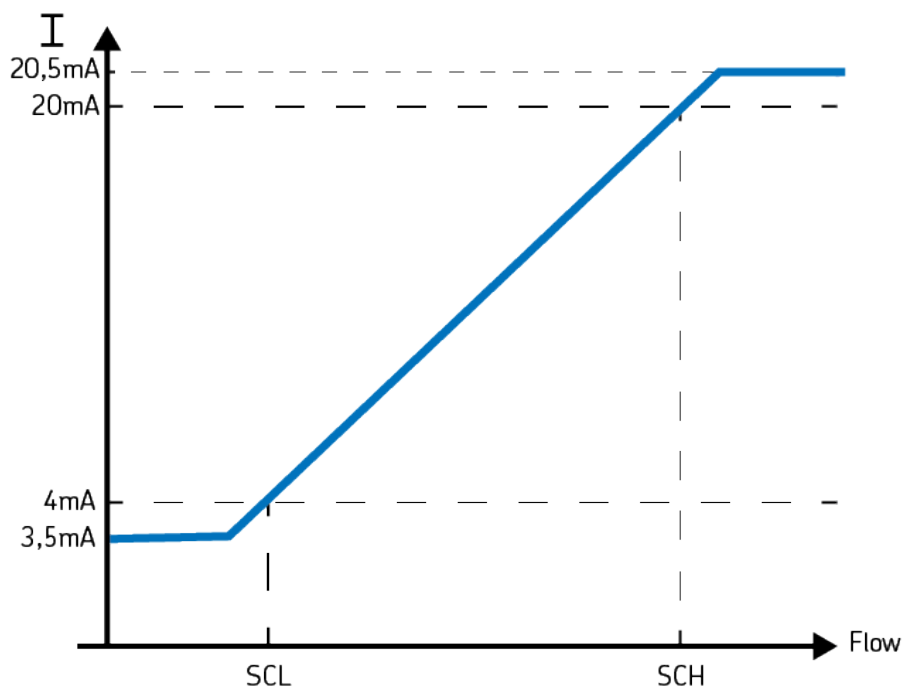
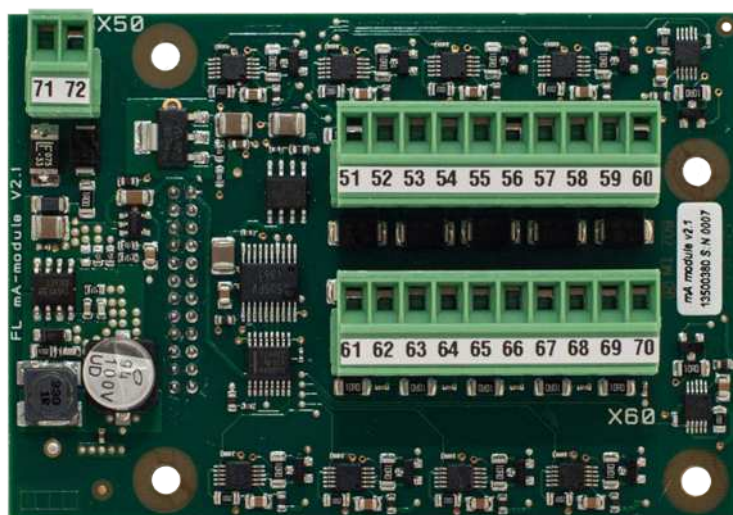

Figure 24 Scaling figure

14.3.3 Connections



There are screw terminals for max. 1,5mm² wires on the module.

The FL mA module requires that a separate voltage supply for current outputs is connected to terminals

- 71: 24VDC+20%. (19,2 ... 28,8VDC)
- 72: 0V

The current outputs are galvanically isolated from the supply voltage of FL monitor.
 If isolation is not required, terminals 71 and 72 can be connected to the supply voltage of FL monitor.
 In this case the supply voltage of the monitor is limited to 24VDC+-20%.

Table 19 Connections

Terminal	Signal, FL-15
51 ***	4 ...20 mA output, flowmeter 1
52 ***	0
53	4 ...20 mA output, flowmeter 2
54	0
55	4 ...20 mA output, flowmeter 3
56	0
57	4 ...20 mA output, flowmeter 4
58	0
59	4 ...20 mA output, flowmeter 5
60	0
61	4 ...20 mA output, flowmeter 6
62	0
63	4 ...20 mA output, flowmeter 7
64	0
65	4 ...20 mA output, flowmeter 8
66	0
67	4 ...20 mA output, flowmeter 9
68	0
69	4 ...20 mA output, flowmeter 10
70	0
71	Current loop supply 24V +-20%, 200mA max.
72	Current loop supply 0V

*** When using FL 50 or FL 100 signal output 51 and 52 are used.

15 Troubleshooting

	<p>WARNING</p> <p>Before disassembling or removing the monitor, the monitor must be disconnected from its power source and all lubrication point oil connections to the monitor must be closed.</p>
	<p>WARNING</p> <p>Before and after disassembling or removing the monitor make sure that the monitor is not hot and/or environment is clean.</p>

Table 20 Troubleshooting

Operation disturbance	Cause of operation disturbance	Solution
Monitor does not have any lights on when operating voltage is connected.	<ol style="list-style-type: none"> 1. No power input voltage. 2. Group electronics have been damaged. 	Check voltage and connectors X9 and X10 Replace group electronics board.
Three horizontal lines (hyphens) on display (- - -) instead of flow rate	Control unit cannot connect to flow sensor. <ol style="list-style-type: none"> 1. Sensor is not properly installed. 2. Sensor has been damaged. 	Check sensor installation. Check the flat cable between the mother board and the group electronics Replace sensor.
When power is switched on all LED's in control unit are blinking and all display segments stay on (more than 10 seconds).	Group electronics board is damaged.	Replace group electronics board.
After start up only flow meter LED's- are lit. Display is blank.	Group electronics board is damaged.	Replace group electronics board.
Some of the flow meters have yellow and red LED-signals on at the same time.	Control unit cannot connect to flow sensor.	Turn power off and on at the monitor. Replace sensor
The alarm relay is in alarm mode, although none of the sensors are in alarm mode.	The alarm settings of some of the non-existing flow meters have been set >0. (For example in FL15-06 the flow meters 7 – 10 are non-existing.)	Enter the setting mode and set the nominal flow, low and high alarm limit values of the non-existing flow meters to "0".
Code E02 is displayed, when temperature is selected on the display.	Temperature measurement failed.	Check the flat cable between the mother board and the group electronics Replace the mother board.
Code E01 is displayed.	The flow meters have not been configured.	Set all flow meter-specific and monitor-specific parameters. Group electronics board may be defective.

16 Cleaning

	WARNING
	<p>CAUTION! Conduct cleaning only on depressurised products that have been disconnected from the power supply. Do not touch cables or electrical components with wet or damp hands.</p> <p>Use steam-jet cleaners or pressure washers only in accordance with the IP protection class of the pump. Otherwise electrical components may be damaged.</p> <p>Follow the operator's standard operating procedures and instructions concerning cleaning, cleaning agents, suitable tools and personal protective equipment.</p>

16.1 Cleaning agents

Use only cleaning agents compatible with the material. For further information, see Chapter 4.14: Material compatibility.

	<p>Thoroughly remove cleaning agent residues from the product and rinse with clear water.</p>
--	---

16.2 Exterior cleaning

- Mark and secure wet areas.
- Keep unauthorized persons away.
- Clean all outer surfaces thoroughly with a damp cloth

16.3 Interior cleaning

Interior cleaning is not usually required. However, if incorrect or contaminated lubricant has been used, the product must be cleaned on the inside. To do so, contact the SKF Customer Service for further instructions.

17 Spare parts



Figure 25 FL-KIT-END 13120450



Figure 26 FL-KIT-COVER 13120460



- 1 pc flowtube assembly
- 3 pcs O-rings
- 1 pc laminator
- 1 pc spring
- 1 pc cover
- 1 pc plug
- 1 pc upper flange

Figure 27 FL15-KIT-FLOWTUBE-A 13120472



- 1 pc flowtube assembly
- 1 pc flowtube kit B
- 2 pcs springs
- 2 pcs laminators
- 2 pcs covers
- 2 pcs plugs
- 6 pcs O-rings
- 2 pcs upper flanges

Figure 28 FL50-KIT-FLOWTUBE-A 13120477 (2 pcs in FL100)

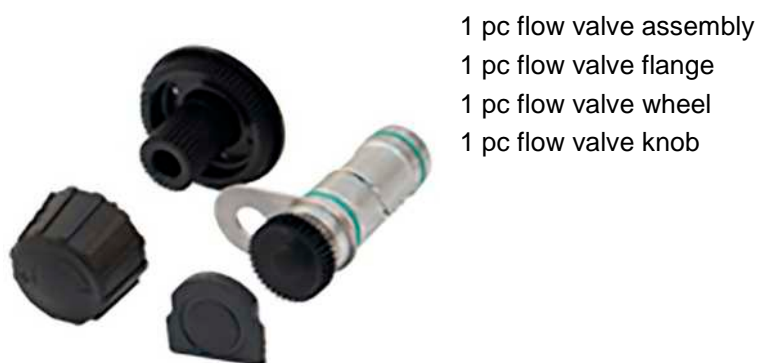

- 1 pc flow valve assembly
- 1 pc flow valve flange
- 1 pc flow valve wheel
- 1 pc flow valve knob

Figure 29 FL15-KIT-VALVE-A 13120480



- 1 pc flow valve assembly
- 1 pc locking ring
- 1 pc flow valve wheel
- 1 pc ring
- 1 pc flow valve knob

Figure 30 FL50-KIT-VALVE 13120485 (2 pcs in FL100)



Figure 31 FL NON RETURN VALVE 13771880



10 pcs knobs

Figure 32 FL-KIT-KNOB 13120487



- 1 pc casing bottom
- 2 pcs O-rings
- 3 pcs screws
- 1 pc plug
- 1 pc seal

Figure 33 FL-KIT-BOTTOM 13120490

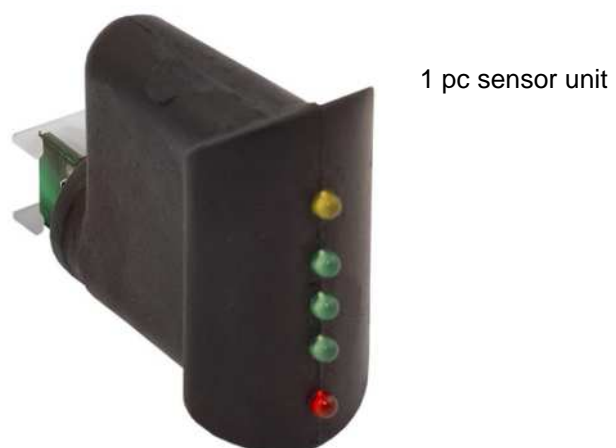

Figure 34 SENSOR-UNIT 13500310



Figure 35 FL-MOTHERBOARD

Table 21 FL-MOTHERBOARD ITEM NUMBERS

1. 13500320	For FL15-02-XXX	For FL50-01-XXX
2. 13500321	For FL15-04-XXX	For FL100-01-XXX
3. 13500322	For FL15-06-XXX	
4. 13500323	For FL15-08-XXX	
5. 13500324	For FL15-10-XXX	

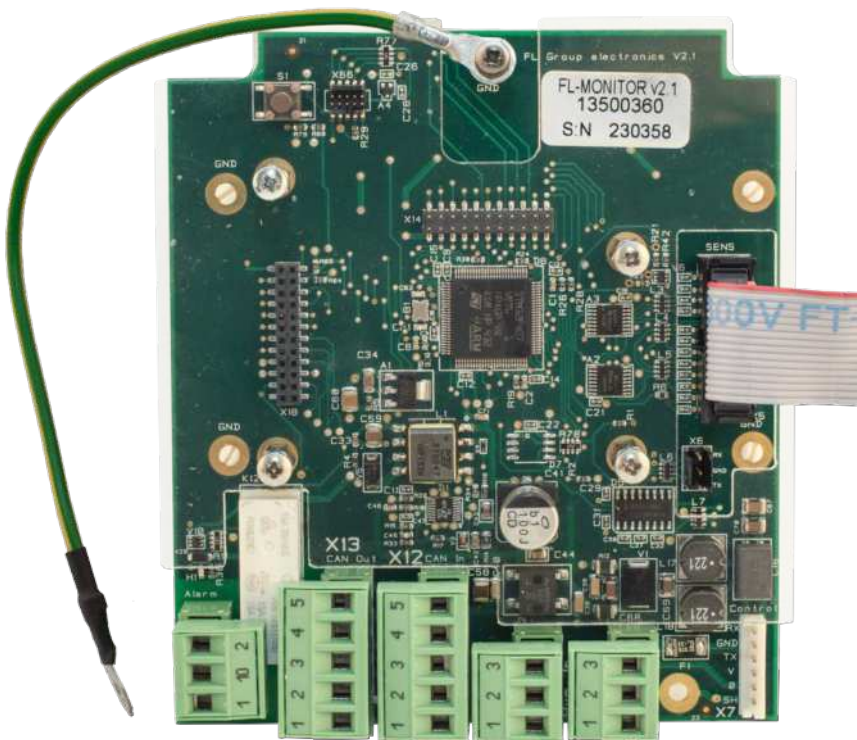

Figure 36 FL GROUP ELECTRONICS V2.1 13500360

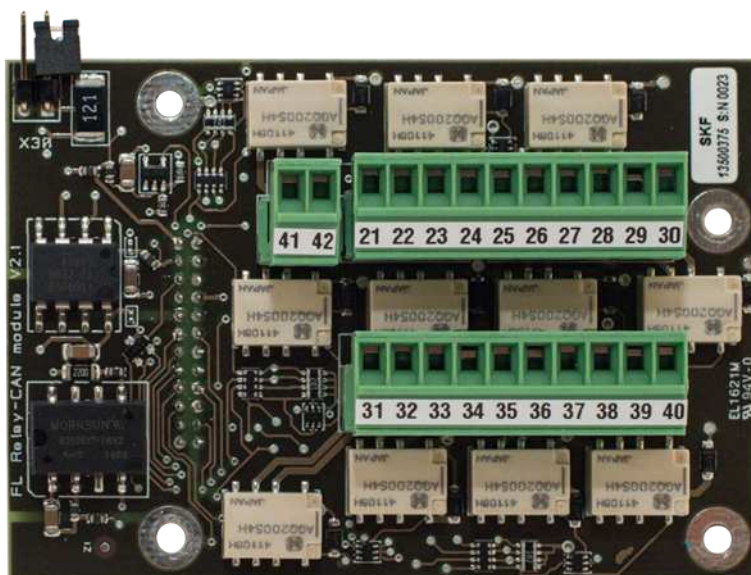

Figure 37 RELAY-CAN MODULE v.2.1 13500375 (OPTIONAL)

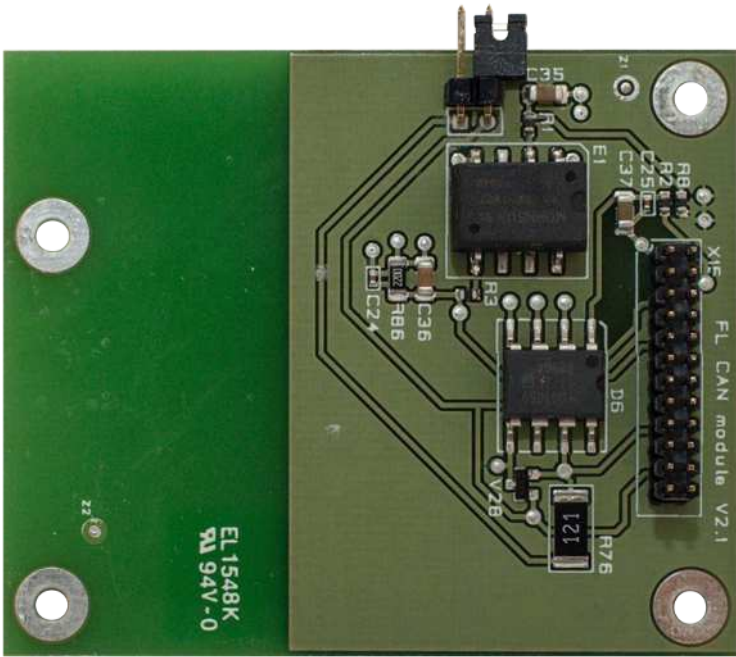

Figure 38 CAN BUS INTERFACE MODULE v.2.1 13500365 (OPTIONAL)

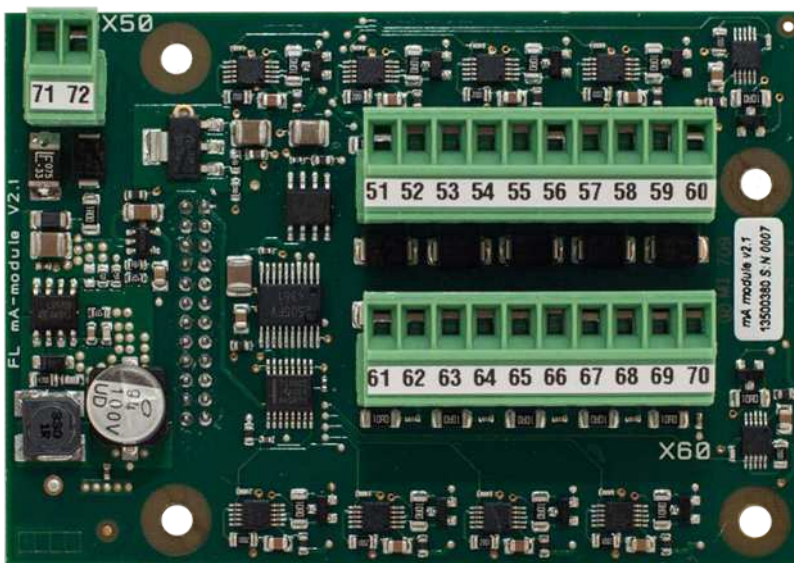

Figure 39 mA-OUTPUT MODULE v.2.1 13500380 (OPTIONAL)

1. Body	6. Group electronics	11. O-ring 3.3x2.4
2. End plate	7. Cover	12. Allen screw M5x12H
3. Motherboard	8. Membrane keyboard	13. Allen screw M5x35 H
4. Casing bottom plate	9. O-ring 25.3x2.4	14. CAN module, Relay-CAN module or mA-output module card
5. Seal	10. O-ring 22.2x3	15. Plug

Table 22 SKF Flowline monitor FL 15, parts

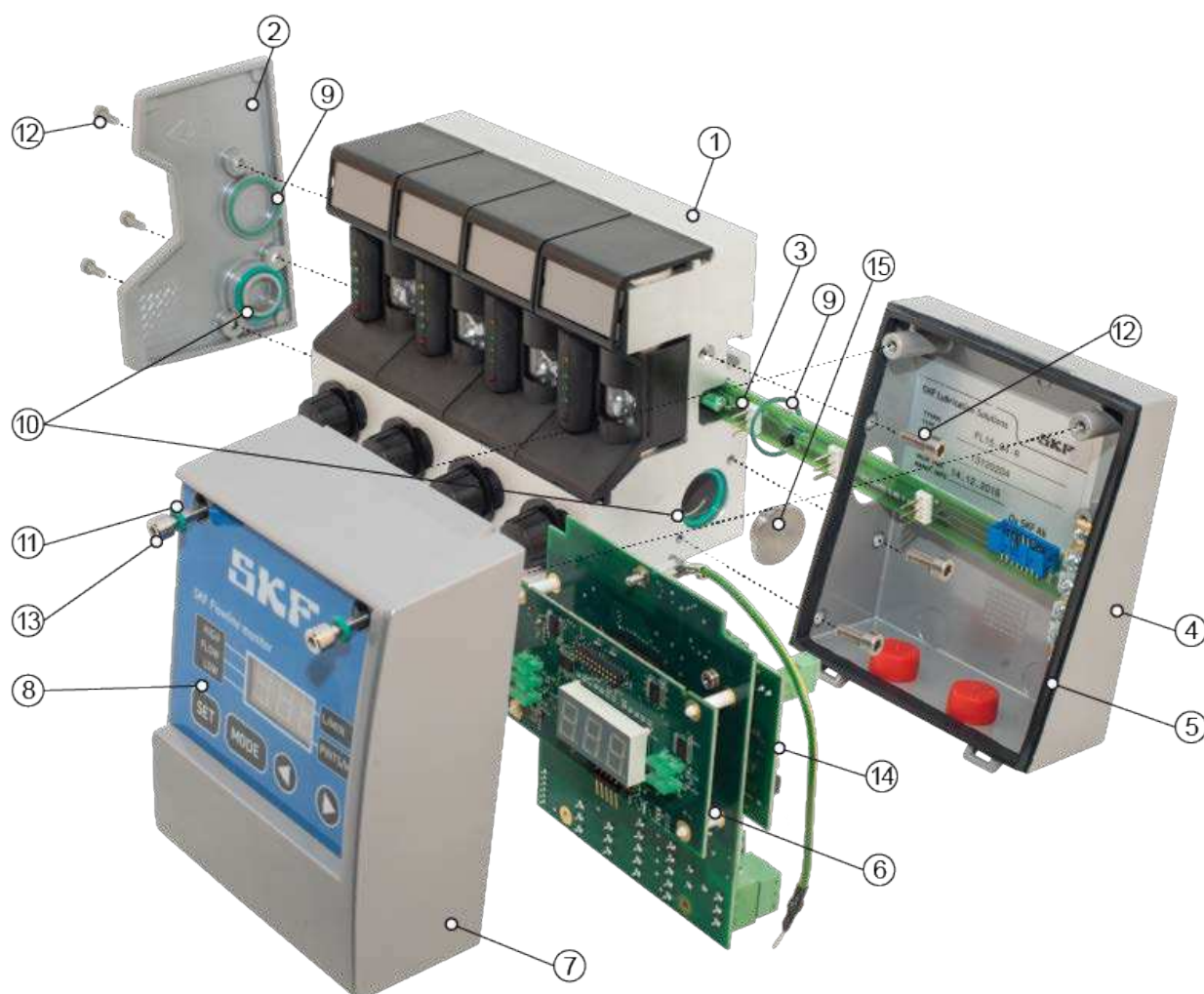
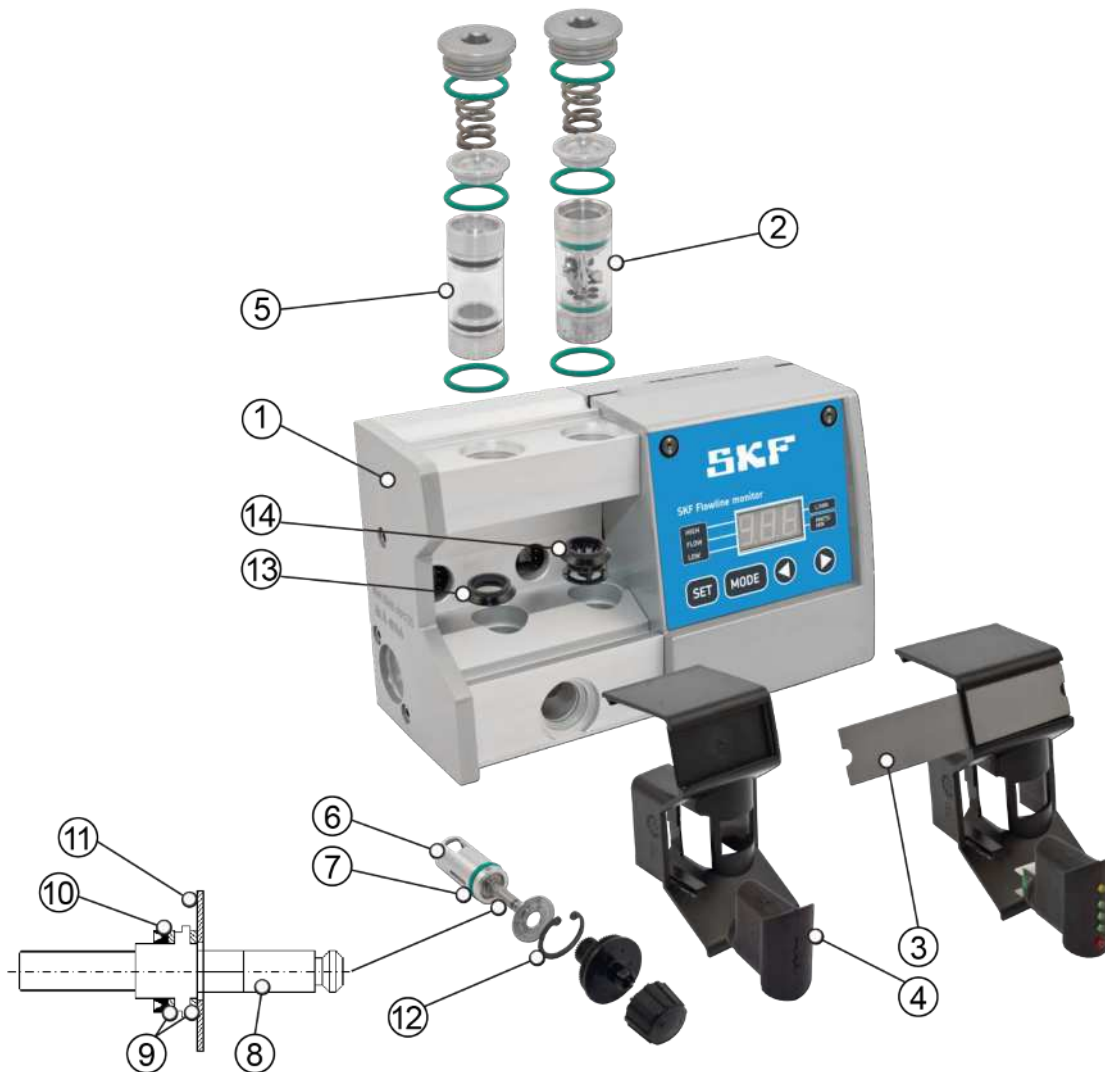

Figure 40 SKF Flowline monitor FL15, exploded view

Table 23 SKF Flowline monitor FL 50 and FL100, parts

1. Body	8. Flow valve shaft
2. Flowtube assembly	9. PTFE ring
3. Position sign	10. Grooved ring
4. Sensor unit B	11. Ring 23,5x1
5. Flowtube	12. Locking ring
6. Flow valve	13. Laminator FL-50
7. O-ring 15,3x2,4	14. Laminator FL



SKF Flowline monitor FL50, exploded view

1. Body	9. PTFE ring
2. Flowtube assembly	10. Grooved ring
3. Position sign	11. Ring 23,5x1
4. Sensor unit B	12. Locking ring
5. Flowtube	13. Laminator FL-50
6. Flow valve	14. Laminator FL
7. O-ring 15,3x2,4	15. Postion sign
8. Flow valve shaft	

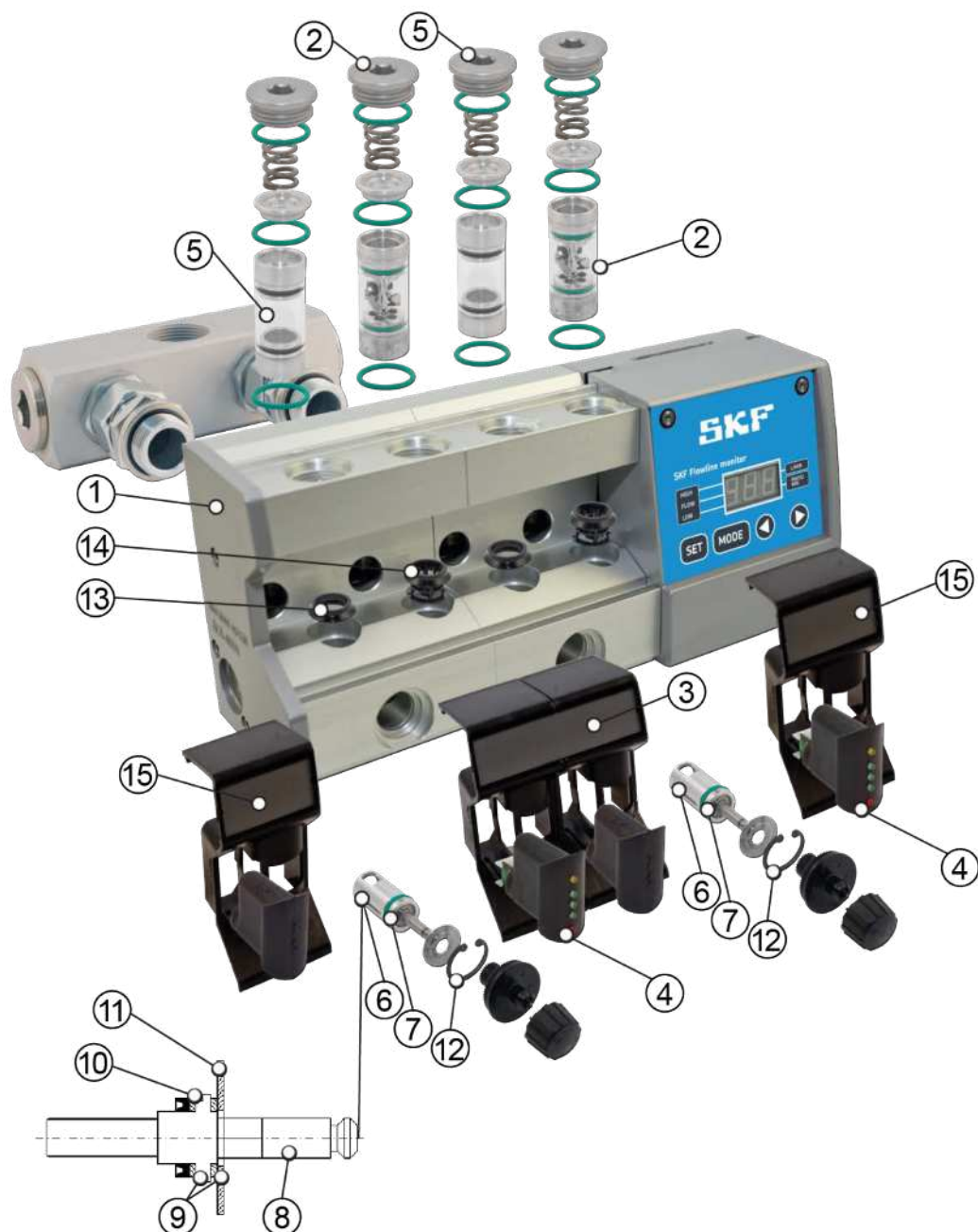

These spare parts fits to FL100